

lucido[®]
sliding systems

**PRODUCT
BROCHURE**



sliding systems

www.lucido.com.tr

Sürme Sistemleri
Sliding Systems



Sürme Kapak Sistemleri
Sliding Systems

P 6-43



Sürme Kapı Sistemleri
Sliding Door Systems

P 44-53



Aksesuar
Accessories

P 54-59

**Sürme Kapak Sistemi / Sliding System****Sürme Kapı Sistemi / Sliding Door System****Karma Üst Taşıyıcı / Combined Top Carrier****İçten Sistem / Internal System****Karma Alt Taşıyıcı / Combined Bottom Carrier****Dıştan Sistem / External System****Üst Taşıyıcı / Top Carrier****Ahşap - Cam / Wooden - Glass****Cam / Glass****Ahşap / Wooden****Tek Yön Yavaşlatıcı / Single Soft Closing****Çift Yön Yavaşlatıcı / Double Soft Closing****Panel Kalınlık / Panel Thickness****Ağırlık / Weight****Yatay Ayarlı / Horizontal Adjustable****Dikey Ayarlı / Vertical Adjustable****Kutu İçi Miktar / Box Quantity****Montaj Şeması / Mounting Instruction****Yağlı Piston Sistemi / Oil Damper System****Havalı Piston Sistemi / Air Damper System****Sürme Kapı Yandan / Side Mounted Sliding Door****Sürme Kapı Üstten / Top Mounted Sliding Door**

Lucido, 2009 yılında sürme kapı, kapak sistemleri ve aksesuarlarını üretmek amacı ile Starax bünyesinde kurulmuştur.

Mobilya sektörünün ihtiyacı olan sürme kapı, kapak sistemlerini, AR-GE çalışmaları ile beklenen kalitede ve zamanda üretmeyi hedefleyen Starax, Lucido markası ile iç ve dış pazarda hızla yer almaktadır.

Kısa zaman içerisinde müşterilerin talepleri doğrultusunda ürün gamını; Sürme Kapak Sistemleri Grubu, Sürme Kapı Sistemleri Grubu ve Aksesuar Grubu ürünleri ile belirli bir seviyeye ulaştırmıştır.

Lucido ürünleri; Starax'ın modern ve teknolojik üretim hatlarında, işinde uzman dinamik kadrosu tarafından kaliteden ödün vermeden üretilmektedir.

Lucido has been established within Starax to produce Sliding Systems, Sliding Doors and Accessories in 2009.

Starax targets to produce furniture industry needs for Sliding Systems and Sliding Doors in expected quality and time with R&D activities and also having a good reputation with Lucido brand name in abroad and domestic market.

Product range reaches a certain high level according to the demands of customers within a short time by Sliding Systems, Sliding Door Systems and Accessories Group products.

Lucido products are produced inside of Starax modern and technological production lines with a specialized dynamic team in the work without any compensation from product quality.

SQR CERTIFICATION

Sertifika
CERTIFICATE

STAR MUTFAK VE MOBİLYA AKSESUARLARI SAN. VE TİC. A.Ş.

VELİMEŞE ORGANİZE SANAYİ BÖLGESİ MAH. 236 SK. NO:18
ERGENE/TEKİRDAĞ/TÜRKİYE

ISO 9001:2015

Kapsam/Scope
MUTFAK, BANYO VE MOBİLYA AKSESUARLARI ÜRETİMİ
PRODUCTION OF KITCHEN, BATH AND FURNITURE ACCESSORIES

EA : 23

Bu sertifika ile yukarıda adı geçen kuruluşun Kalite Yönetim Sistemi gerekliliklerini karşıladığı tasdik olunur.
This is to certify that the above mentioned company meets the requirement of Quality Management System.

Sertifika No / Certification Number	: MTS-31980
İlk Kayıt Tarihi / Date of Initial Reg.	: 27.07.2023
Başım Tarihi / Date of Certificate	: 8.07.2024
Geçerlilik Tarihi / Date of Expiry	: 26.07.2025
Revizyon / Revision	: 001

Bu sertifika kuruluşun belgelendirme periyodu boyunca ve yılda en az 1 kez yapılacak olan güncellenme dönemlerinde başarıya geçmesi halinde bu yılda sertifikasyon periyodu bir yıl uzatılarak geçerlidir.
This certificate is valid until the end of the three-year certification period if the organization complies with the certification requirements and the surveillance audits to be carried out at least once a year are completed successfully.

Genel Müdür / General Manager

SIĞACERT ULUSLARARASI BELGELENDİRME EĞİTİM VE TEST HİZMETLERİ LTD. ŞTİ.
Büyükdere Mahallesi Sanayi Bulvarı Şişli İşletme Plaza No:18/25 Etiler/Beşiktaş/İstanbul
www.sigacert.com.tr belgelendirme@sigacert.com.tr ☎+90 312 385 98 85
YS.FR.129 Rev.02.26.02.2024

IAF **IAS**

SQR CERTIFICATION

Sertifika
CERTIFICATE

STAR MUTFAK VE MOBİLYA AKSESUARLARI SAN. VE TİC. A.Ş.

VELİMEŞE ORGANİZE SANAYİ BÖLGESİ MAH. 236 SK. NO:18
ERGENE/TEKİRDAĞ/TÜRKİYE

ISO 10002:2018

Kapsam/Scope
MUTFAK, BANYO VE MOBİLYA AKSESUARLARI ÜRETİMİ
PRODUCTION OF KITCHEN, BATH AND FURNITURE ACCESSORIES

Bu sertifika ile yukarıda adı geçen kuruluşun Müşteri Memnuniyeti Yönetim Sistemi gerekliliklerini karşıladığı tasdik olunur.
This is to certify that the above mentioned company meets the requirement of Customer Satisfaction Management System.

Sertifika No / Certification Number	: MTS-31983
İlk Kayıt Tarihi / Date of Initial Reg.	: 27.07.2023
Başım Tarihi / Date of Certificate	: 8.07.2024
Geçerlilik Tarihi / Date of Expiry	: 26.07.2025
Revizyon / Revision	: 000

Bu sertifika kuruluşun belgelendirme periyodu boyunca ve yılda en az 1 kez yapılacak olan güncellenme dönemlerinde başarıya geçmesi halinde bu yılda sertifikasyon periyodu bir yıl uzatılarak geçerlidir.
This certificate is valid until the end of the three-year certification period if the organization complies with the certification requirements and the surveillance audits to be carried out at least once a year are completed successfully.

Genel Müdür / General Manager

SIĞACERT ULUSLARARASI BELGELENDİRME EĞİTİM VE TEST HİZMETLERİ LTD. ŞTİ.
Büyükdere Mahallesi Sanayi Bulvarı Şişli İşletme Plaza No:18/25 Etiler/Beşiktaş/İstanbul
www.sigacert.com.tr belgelendirme@sigacert.com.tr ☎+90 312 385 98 85
YS.FR.129 Rev.02.26.02.2024

SQR CERTIFICATION

Sertifika
CERTIFICATE

STAR MUTFAK VE MOBİLYA AKSESUARLARI SAN. VE TİC. A.Ş.

VELİMEŞE ORGANİZE SANAYİ BÖLGESİ MAH. 236 SK. NO:18
ERGENE/TEKİRDAĞ/TÜRKİYE

ISO 14001:2015

Kapsam/Scope
MUTFAK, BANYO VE MOBİLYA AKSESUARLARI ÜRETİMİ
PRODUCTION OF KITCHEN, BATH AND FURNITURE ACCESSORIES

EA : 23

Bu sertifika ile yukarıda adı geçen kuruluşun Çevre Yönetim Sistemi gerekliliklerini karşıladığı tasdik olunur.
This is to certify that the above mentioned company meets the requirement of Environmental Management System.

Sertifika No / Certification Number	: MTS-31981
İlk Kayıt Tarihi / Date of Initial Reg.	: 27.07.2023
Başım Tarihi / Date of Certificate	: 8.07.2024
Geçerlilik Tarihi / Date of Expiry	: 26.07.2025
Revizyon / Revision	: 001

Bu sertifika kuruluşun belgelendirme periyodu boyunca ve yılda en az 1 kez yapılacak olan güncellenme dönemlerinde başarıya geçmesi halinde bu yılda sertifikasyon periyodu bir yıl uzatılarak geçerlidir.
This certificate is valid until the end of the three-year certification period if the organization complies with the certification requirements and the surveillance audits to be carried out at least once a year are completed successfully.

Genel Müdür / General Manager

SIĞACERT ULUSLARARASI BELGELENDİRME EĞİTİM VE TEST HİZMETLERİ LTD. ŞTİ.
Büyükdere Mahallesi Sanayi Bulvarı Şişli İşletme Plaza No:18/25 Etiler/Beşiktaş/İstanbul
www.sigacert.com.tr belgelendirme@sigacert.com.tr ☎+90 312 385 98 85
YS.FR.129 Rev.02.26.02.2024

IAF **IAS**

SQR CERTIFICATION

Sertifika
CERTIFICATE

STAR MUTFAK VE MOBİLYA AKSESUARLARI SAN. VE TİC. A.Ş.

VELİMEŞE ORGANİZE SANAYİ BÖLGESİ MAH. 236 SK. NO:18
ERGENE/TEKİRDAĞ/TÜRKİYE

ISO 45001:2018

Kapsam/Scope
MUTFAK, BANYO VE MOBİLYA AKSESUARLARI ÜRETİMİ
PRODUCTION OF KITCHEN, BATH AND FURNITURE ACCESSORIES

EA : 23

Bu sertifika ile yukarıda adı geçen kuruluşun İş Sağlığı ve Güvenliği Yönetim Sistemi gerekliliklerini karşıladığı tasdik olunur.
This is to certify that the above mentioned company meets the requirement of Occupational Health & Safety Management System.

Sertifika No / Certification Number	: MTS-31982
İlk Kayıt Tarihi / Date of Initial Reg.	: 27.07.2023
Başım Tarihi / Date of Certificate	: 8.07.2024
Geçerlilik Tarihi / Date of Expiry	: 26.07.2025
Revizyon / Revision	: 001

Bu sertifika kuruluşun belgelendirme periyodu boyunca ve yılda en az 1 kez yapılacak olan güncellenme dönemlerinde başarıya geçmesi halinde bu yılda sertifikasyon periyodu bir yıl uzatılarak geçerlidir.
This certificate is valid until the end of the three-year certification period if the organization complies with the certification requirements and the surveillance audits to be carried out at least once a year are completed successfully.

Genel Müdür / General Manager

SIĞACERT ULUSLARARASI BELGELENDİRME EĞİTİM VE TEST HİZMETLERİ LTD. ŞTİ.
Büyükdere Mahallesi Sanayi Bulvarı Şişli İşletme Plaza No:18/25 Etiler/Beşiktaş/İstanbul
www.sigacert.com.tr belgelendirme@sigacert.com.tr ☎+90 312 385 98 85
YS.FR.129 Rev.02.26.02.2024





Sliding Systems

**Sürme Kapak
Sistemleri**

LC15

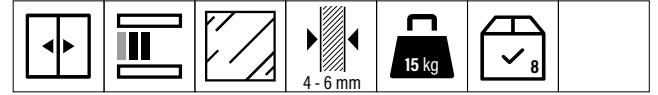

PDF

1 Set İçeriği | 1 Set Includes



Code	T (mm)	Box	Volume (m³)	Weight (kg)	Birim / Unit
L-1101	4-6	288	0,027	12,72	1Tk-1 Kapak / 1 Set - 1 Doors

Technical Drawing	Code	T (mt)	Bağ Band	Volume (m³)	Weight (kg)	Unit
<p>Alüminyum Üst Ray / Upper Rail</p>	L-3101	3.00	15	0,0168	0,06240	Adet Pcs
<p>Alüminyum Gövde Rayı / Body Rail</p>	L-3102	3.00	10	0,0105	0,7710	Adet Pcs
<p>Alüminyum Alt Ray / Bottom Rail</p>	L-3103	3.00	30	0,012	0,4410	Adet Pcs
<p>Cam Dolgu Fitolü / Thin Glass Filling</p>	L-3751	100	200	-	-	Mt

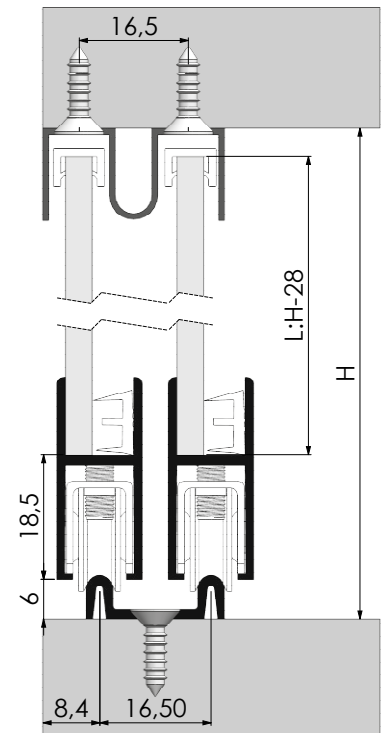

LC MIX 15

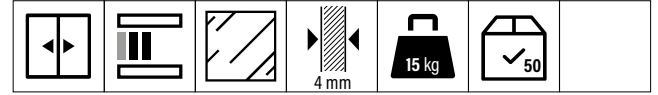

PDF

1 Set İeriđi | 1 Set Includes

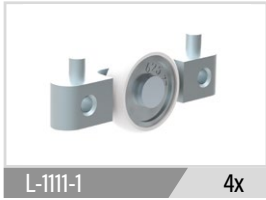

L-1111-1

4x

Code	T (mm)	Box	Volume (m ³)	Weight (kg)	Birim / Unit
L-1111	20	300	0,035	35,54	1Tk - 1 Kapak / 1 Set - 1 Doors

Technical Drawing	Code	T (mt)	Bađ Band	Volume (m ³)	Weight (kg)	Unit
<p>Alüminyum Çereve Profili / Frame Profile</p>	L-3602	3.00	10	-	-	Adet Pcs
<p>Alüminyum Çereve Profili / Frame Profile</p>	L-3605	3.00	10	-	-	Adet Pcs
<p>Alüminyum Alt-Üst Ray / Bottom-Upper Rail</p>	L-3104	3.00	20	0,0135	0,300	Adet Pcs

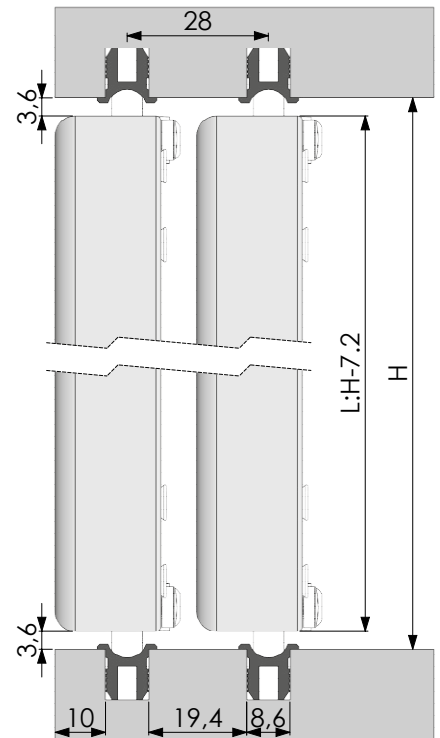

LC MIX 15 ADAPTÖRLÜ / WITH ADAPTER

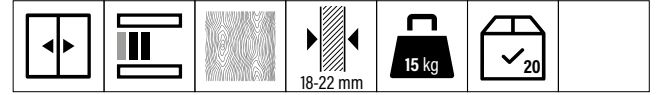

PDF

1 Set İçeriği | 1 Set Includes



L-1112-1

4x

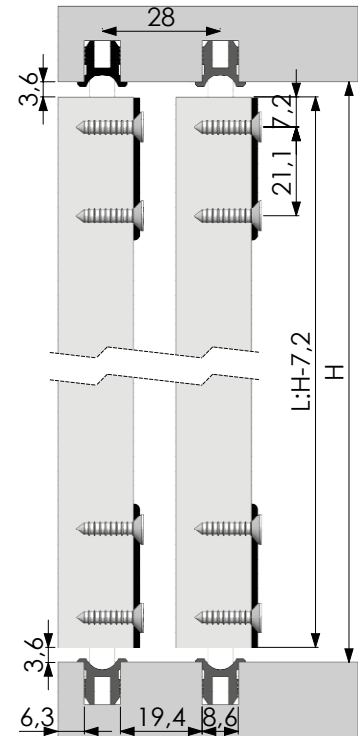

Code	T (mm)	Box	Volume (m³)	Weight (kg)	Birim / Unit
L-1112	18-22	120	0,035	32,98	1Tk - 1 Kapak / 1 Set - 1 Doors

Technical Drawing	Code	T (mt)	Bağ Band	Volume (m³)	Weight (kg)	Unit
<p>Alüminyum Alt-Üst Ray / Bottom-Upper Rail</p>	L-3104	3.00	20	0,0135	0,300	Adet Pcs

LC30

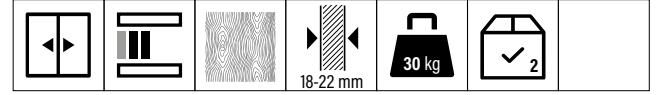

PDF

1 Set İçeriği | 1 Set Includes

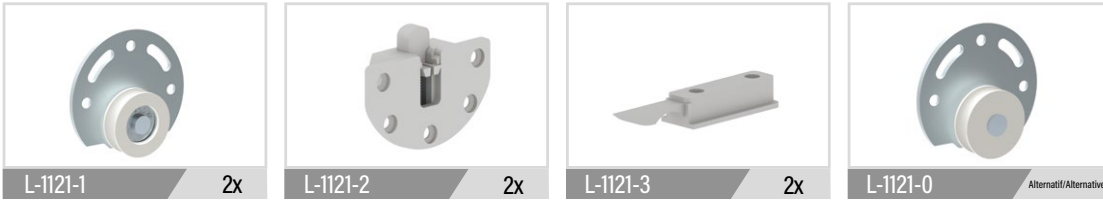

Code	T (mm)	Box	Volume (m³)	Weight (kg)	Birim / Unit
L-1121	18-22	72	0,027	786	1 Tk - 1 Kapak / 1 Set - 1 Doors

Technical Drawing	Code	T (mt)	Bağ Band	Volume (m³)	Weight (kg)	Unit
<p>PVC Üst Ray / Upper Rail</p>	L-3703	3.00	50	0,0225	0,200	Adet Pcs
<p>PVC Alt Ray / Bottom Rail</p>	L-3701	3.00	50	0,03375	0,165	Adet Pcs
<p>Alüminyum Alt Ray / Bottom Rail</p>	L-3106	3.00	50	0,3375	0,300	Adet Pcs

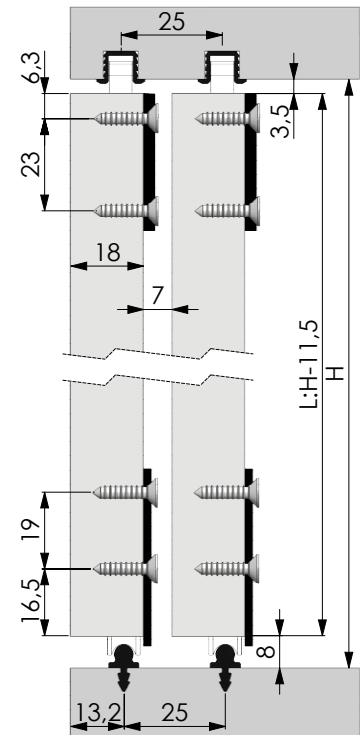

LC40

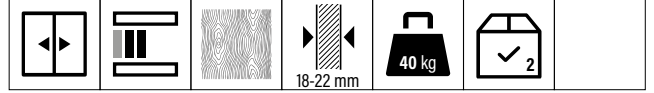

PDF

1 Set İçeriği | 1 Set Includes



Code	T (mm)	Box	Volume (m³)	Weight (kg)	Birim / Unit
L-1125	18-22	72	0,027	11,32	1 Tk - 1 Kapak / 1 Set - 1 Doors

Technical Drawing	Code	T (mt)	Bağ Band	Volume (m³)	Weight (kg)	Unit
<p>PVC Üst Ray / Upper Rail</p>	L-3703	3.00	50	0,0225	0,200	Adet Pcs
<p>Alüminyum Alt-Üst Ray / Bottom-Upper Rail</p>	L-3130	3.00	40	0,036	0,300	Adet Pcs

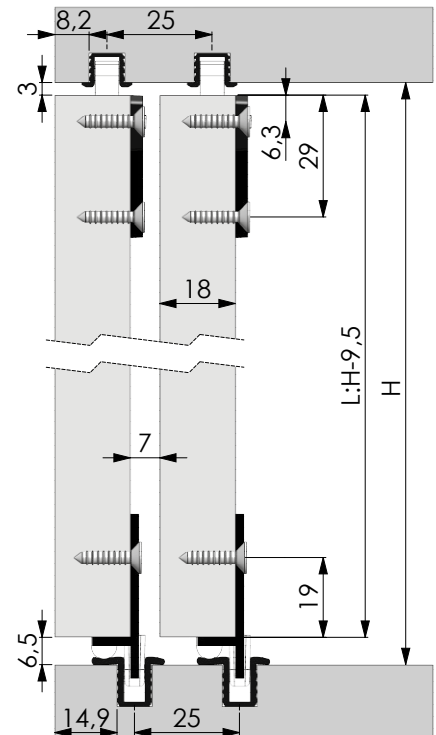

LC41

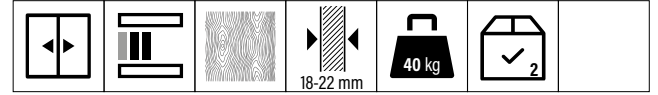

PDF

1 Set İçeriği | 1 Set Includes



L-1125-1 2x

L-1126-2 2x

L-1126-3 2x

Code	T (mm)	Box	Volume (m ³)	Weight (kg)	Birim / Unit
L-1126	18-22	72	0,027	13,1	1Tk- 1Kapak / 1 Set - 1 Doors

Technical Drawing	Code	T (mt)	Bağ Band	Volume (m ³)	Weight (kg)	Unit
<p>Alüminyum Alt-Üst Ray / Bottom-Upper Rail</p>	L-3130	3.00	40	0,036	0,300	Adet Pcs

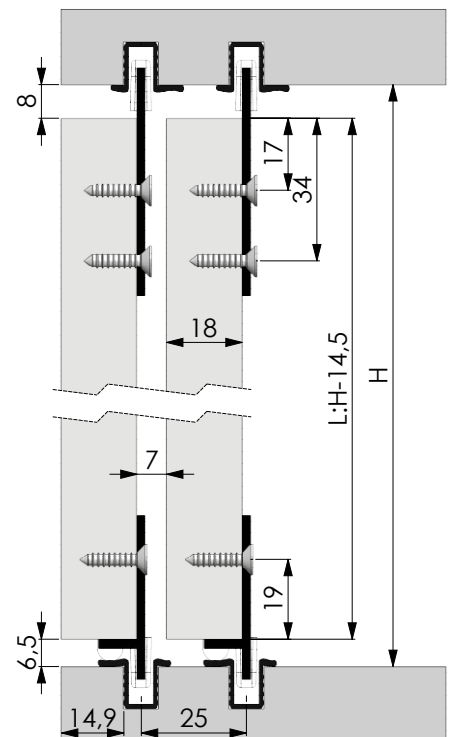



LC53

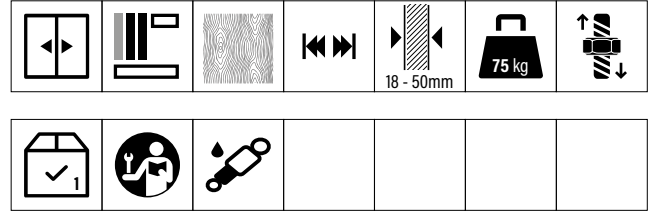

PDF

1 Set İçeriği | 1 Set Includes

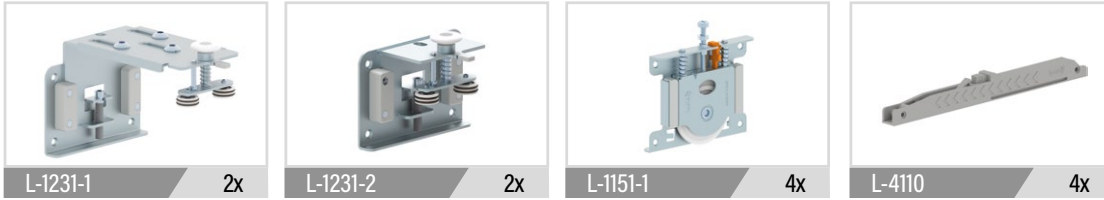

Code	T (mm)	Box	Volume (m³)	Weight (kg)	Birim / Unit
L-1231	18-50	4	0,0361	15,54	1 Tk - 2 Kapak / 1 Set - 2 Doors
L-1232	18-50	4	0,0361	16,68	1 Tk - 3 Kapak / 1 Set - 3 Doors

Technical Drawing	Code	T (mt)	Bağ Band	Volume (m³)	Weight (kg)	Unit
<p>Alüminyum Üst Ray / Upper Rail</p>	L-3173-1	2.00	4	0,0216	2,1000	Adet Pcs
	L-3173-2	2.50		0,027	2,6250	
	L-3173-3	3.00		0,05106	2,800	
<p>PVC Alt Ray / Bottom Rail</p>	L-3703	3.00	50	0,0225	0,200	Adet Pcs

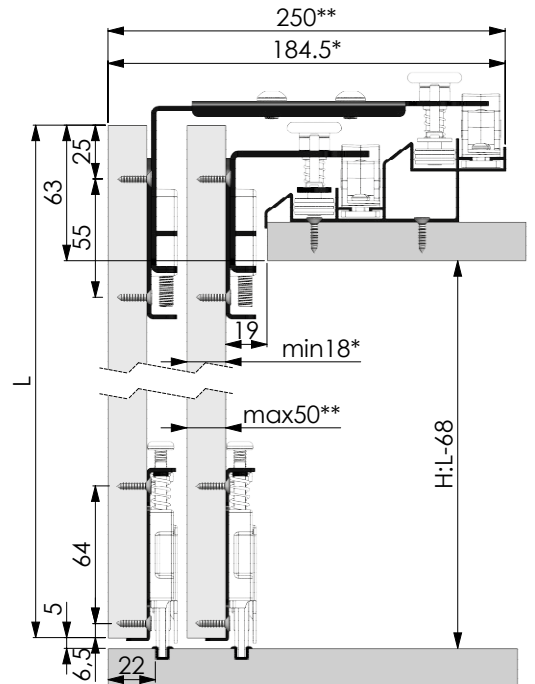

LC54 18-25 mm

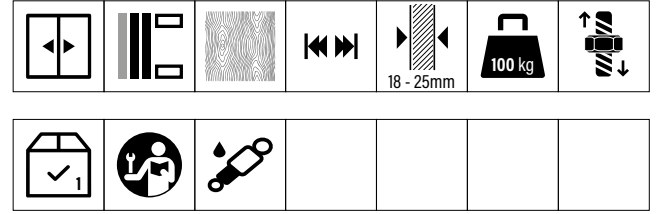

PDF

1 Set İeriđi | 1 Set Includes



Code	T (mm)	Box	Volume (m ³)	Weight (kg)	Birim / Unit
L-1241	18-25	4	0,0361	15,46	1 Tk - 2 Kapak / 1 Set - 2 Doors
L-1244	18-25	4	0,0361	17	1 Tk - 3 Kapak / 1 Set - 3 Doors

Technical Drawing	Code	T (mt)	Bađ Band	Volume (m ³)	Weight (kg)	Unit
<p>Alüminyum Üst Ray / Upper Rail</p>	L-3172-1	2.00	8	0,016	1,6240	Adet Pcs
	L-3172-2	2.50		0,02	2,000	
	L-3172-3	3.00		0,0357	2,200	
<p>Alüminyum Alt Ray / Bottom Rail</p>	L-3171-1	2.00	6	0,011	0,960	Adet Pcs
	L-3171-2	2.50		0,01375	1,200	
	L-3171-3	3.00		0,03321	1,200	

SÜRME KAPAK SİSTEMLERİ SLIDING SYSTEMS



LC54 26-35 mm

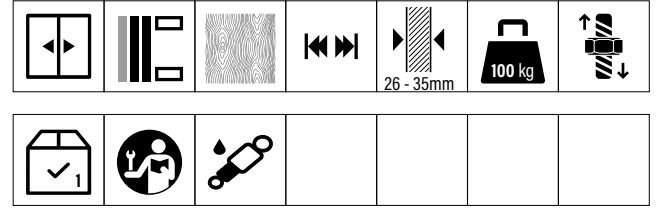

PDF

1 Set İçeriği | 1 Set Includes



Code	T (mm)	Box	Volume (m³)	Weight (kg)	Birim / Unit
L-1242	26-35	4	0,0361	17,26	1 Tk - 2 Kapak / 1 Set - 2 Doors
L-1245	26-35	4	0,0361	18,8	1 Tk - 3 Kapak / 1 Set - 3 Doors

Technical Drawing	Code	T (mm)	Bağ Band	Volume (m³)	Weight (kg)	Unit
<p>Alüminyum Üst Ray / Upper Rail</p>	L-3172-1	2.00	8	0,016	1,6240	Adet Pcs
	L-3172-2	2.50		0,02	2,000	
	L-3172-3	3.00		0,0357	2,200	
<p>Alüminyum Alt Ray / Bottom Rail</p>	L-3171-1	2.00	6	0,011	0,960	Adet Pcs
	L-3171-2	2.50		0,01375	1,200	
	L-3171-3	3.00		0,03321	1,200	

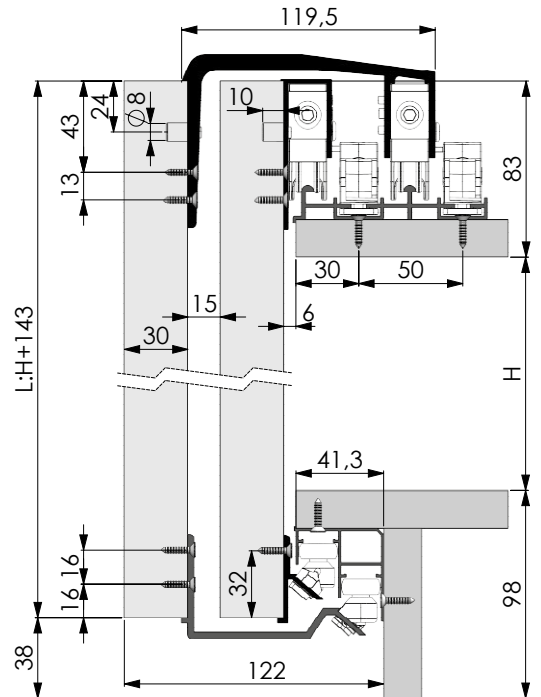

LC54 36-50 mm

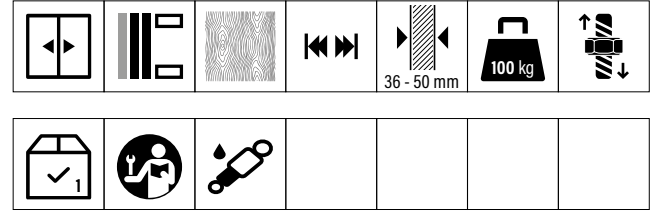

PDF

1 Set İeriđi | 1 Set Includes



Code	T (mm)	Box	Volume (m ³)	Weight (kg)	Birim / Unit
L-1243	36-50	4	0,0361	22,66	1Tk - 2 Kapak / 1 Set - 2 Doors
L-1246	36-50	4	0,0361	24,2	1Tk - 3 Kapak / 1 Set - 3 Doors

Technical Drawing	Code	T (mt)	Bađ Band	Volume (m ³)	Weight (kg)	Unit
<p>Alüminyum Üst Ray / Upper Rail</p>	L-3172-1	2.00	8	0,016	1,6240	Adet Pcs
	L-3172-2	2.50		0,02	2,000	
	L-3172-3	3.00		0,0357	2,200	
<p>Alüminyum Alt Ray / Bottom Rail</p>	L-3171-1	2.00	6	0,011	0,960	Adet Pcs
	L-3171-2	2.50		0,01375	1,200	
	L-3171-3	3.00		0,03321	1,200	

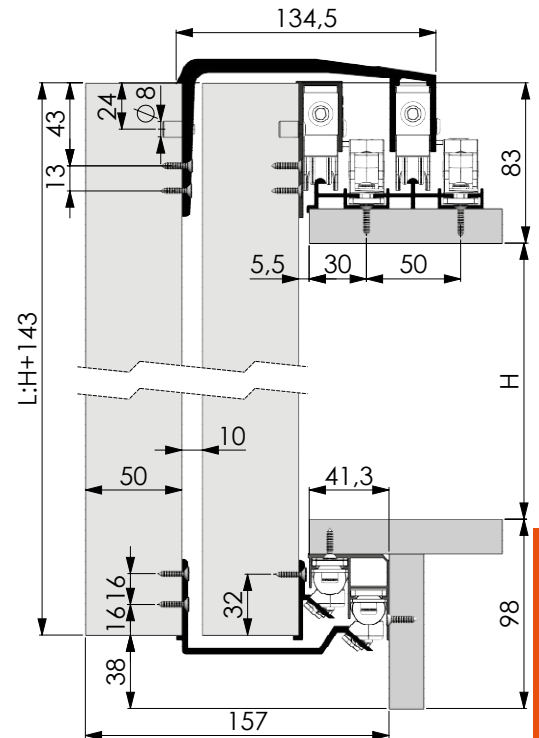

LC55 18-25 mm

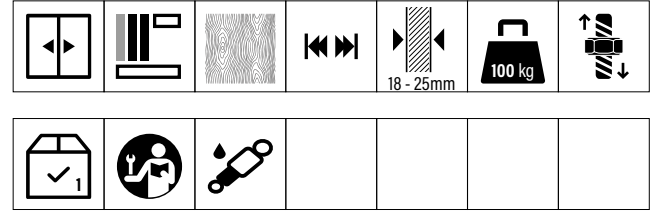

PDF

1 Set İçeriği | 1 Set Includes

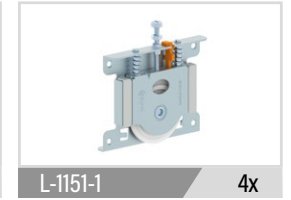
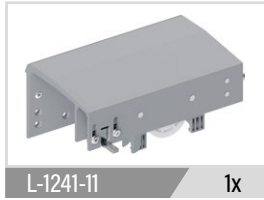
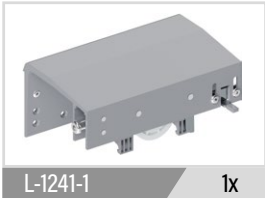

Code	T (mm)	Box	Volume (m³)	Weight (kg)	Birim / Unit
L-1251	18-25	4	0,0361	15,46	1 Tk - 2 Kapak / 1 Set - 2 Doors
L-1254	18-25	4	0,0361	17	1 Tk - 3 Kapak / 1 Set - 3 Doors

Technical Drawing	Code	T (mt)	Bağ Band	Volume (m³)	Weight (kg)	Unit
<p>Alüminyum Üst Ray / Upper Rail</p>	L-3172-1	2.00	8	0,016	1,6240	Adet Pcs
	L-3172-2	2.50		0,02	2,0300	
	L-3172-3	3.00		0,0357	2,200	
<p>PVC Alt Ray / Bottom Rail</p>	L-3703	3.00	50	0,0225	0,200	Adet Pcs

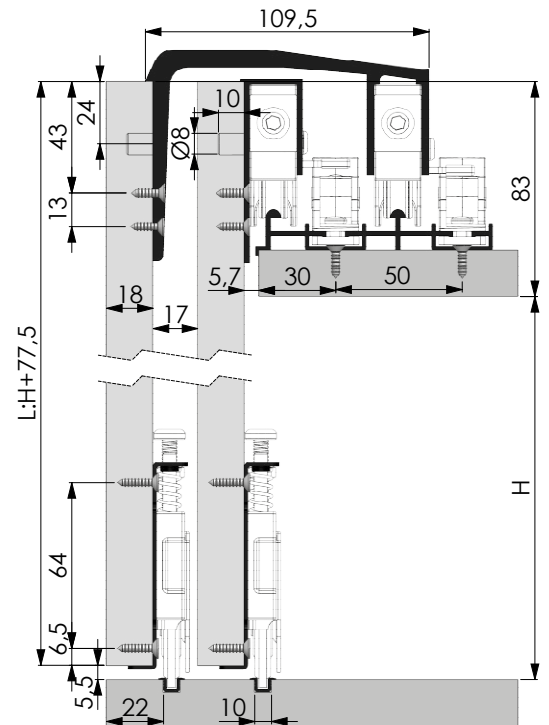

LC55 26-35 mm

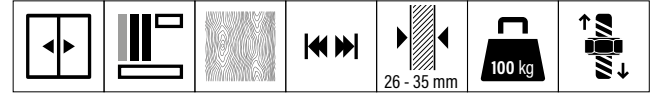

PDF

1 Set İçeriği | 1 Set Includes

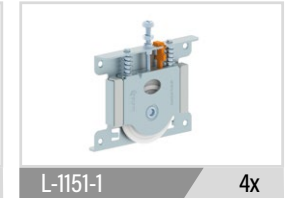
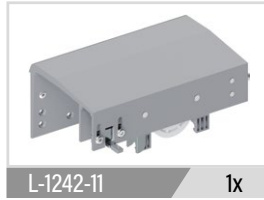
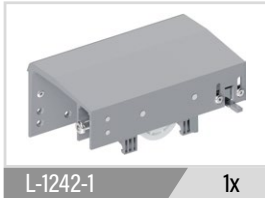

Code	T (mm)	Box	Volume (m³)	Weight (kg)	Birim / Unit
L-1252	26-35	4	0,0361	17,26	1 Tk - 2 Kapak / 1 Set - 2 Doors
L-1255	26-35	4	0,0361	18,8	1 Tk - 3 Kapak / 1 Set - 3 Doors

Technical Drawing	Code	T (mt)	Bağ Band	Volume (m³)	Weight (kg)	Unit
<p>Alüminyum Üst Ray / Upper Rail</p>	L-3172-1	2.00	8	0,016	1,6240	Adet Pcs
	L-3172-2	2.50		0,02	2,0300	
	L-3172-3	3.00		0,0357	2,200	
<p>PVC Alt Ray / Bottom Rail</p>	L-3703	3.00	50	0,0225	0,200	Adet Pcs

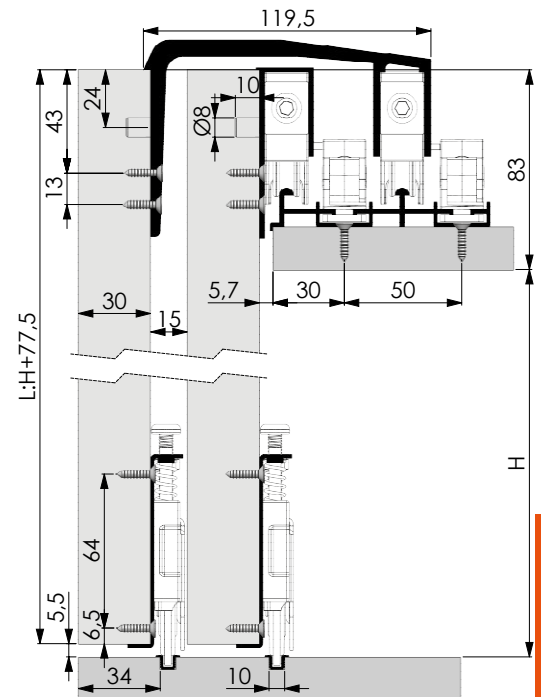



LC55 36-50 mm

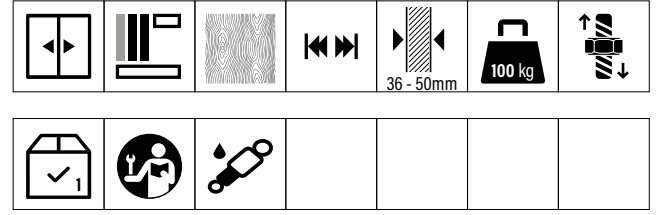

PDF

1 Set İçeriği | 1 Set Includes

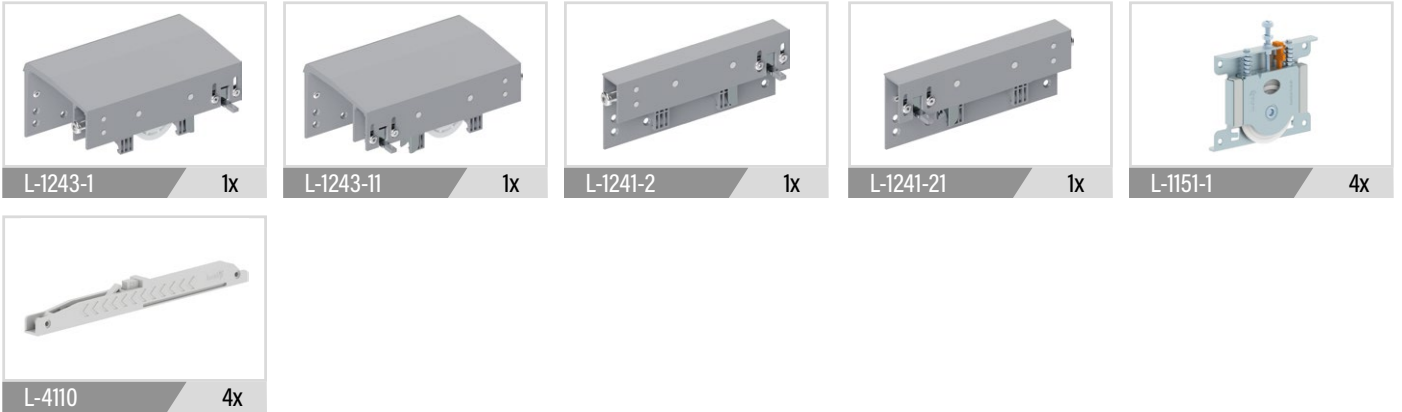

Code	T (mm)	Box	Volume (m³)	Weight (kg)	Birim / Unit
L-1253	36-50	4	0,0361	22,66	1 Tk - 2 Kapak / 1 Set - 2 Doors
L-1256	36-50	4	0,0361	24,2	1 Tk - 3 Kapak / 1 Set - 3 Doors

Technical Drawing	Code	T (mt)	Bağ Band	Volume (m³)	Weight (kg)	Unit
<p>Alüminyum Üst Ray / Upper Rail</p>	L-3172-1	2.00	8	0,016	1,6240	Adet Pcs
	L-3172-2	2.50		0,02	2,0300	
	L-3172-3	3.00		0,0357	2,200	
<p>PVC Alt Ray / Bottom Rail</p>	L-3703	3.00	50	0,0225	0,200	Adet Pcs

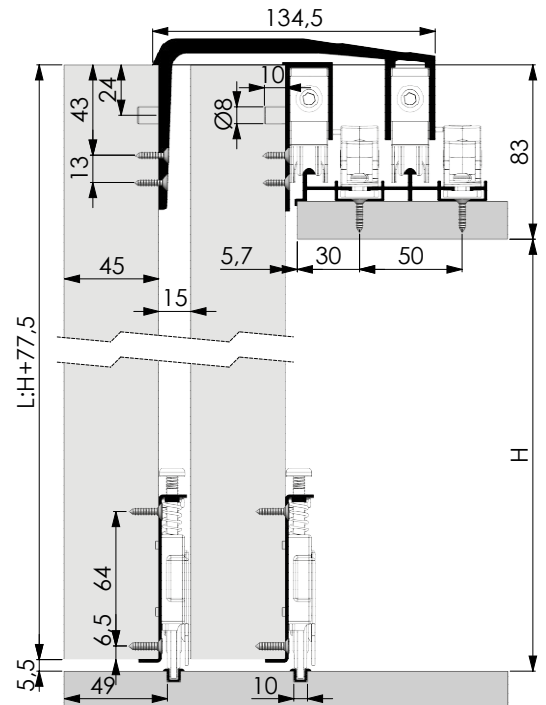

LC60

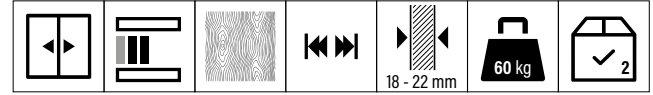

PDF

1 Set İçeriği | 1 Set Includes

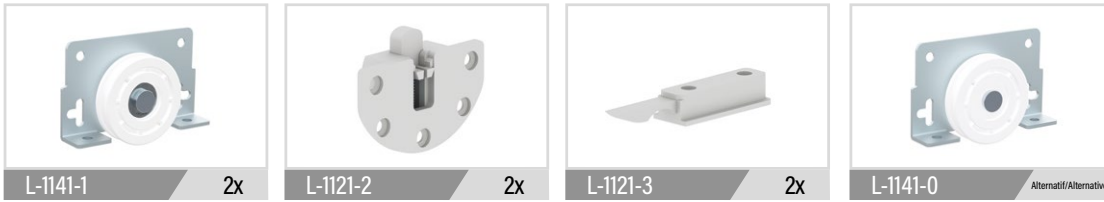

Code	T (mm)	Box	Volume (m ³)	Weight (kg)	Birim / Unit
L-1141	18-22	72	0,027	176	1Tk - 1 Kapak / 1 Set - 1 Doors

Technical Drawing	Code	T (mm)	Bağ Band	Volume (m ³)	Weight (kg)	Unit
<p>PVC Üst Ray / Upper Rail</p>	L-3703	3.00	50	0,0225	0,200	Adet Pcs
<p>PVC Alt Ray / Bottom Rail</p>	L-3701	3.00	50	0,03375	0,165	Adet Pcs
<p>Alüminyum Alt Ray / Bottom Rail</p>	L-3106	3.00	50	0,022	0,300	Adet Pcs

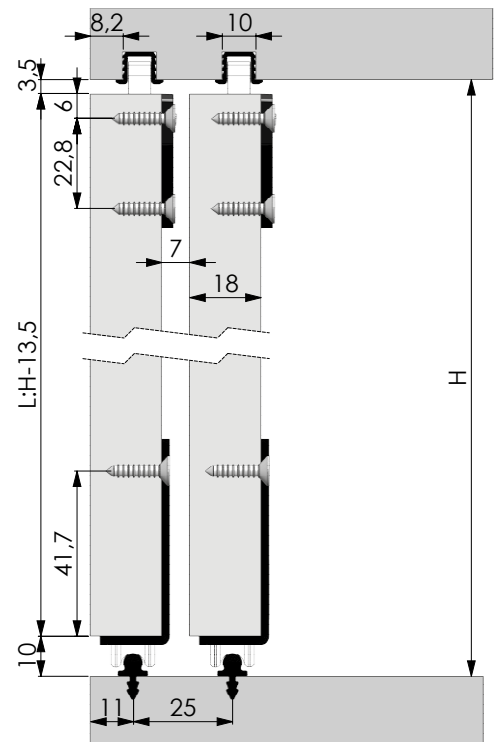

LC75 AY





PDF

1 Set İçeriği | 1 Set Includes

	L-1151-1	1x		L-1151-3	1x		L-4109	Opsiyonel/Optional
--	----------	----	--	----------	----	--	--------	--------------------

Code	T (mm)	Box	Volume (m³)	Weight (kg)	Birim / Unit
L-1151	18-22	108	0,025	25,9	1 Adet / 1 Piece

Technical Drawing	Code	T (mt)	Bağ Band	Volume (m³)	Weight (kg)	Unit
<p>Alüminyum Alt-Üst Ray / Bottom-Upper Rail</p>	L-3110-1	2.00	20	0,024	0,500	Adet Pcs
	L-3110-2	2.50		0,03	0,500	
	L-3110-3	3.00		0,036	0,700	
<p>Alüminyum Alt-Üst Ray / Bottom-Upper Rail</p>	L-3111-1	2.00	20	0,0012	0,4520	Adet Pcs
	L-3111-2	2.50		0,0015	0,5650	
	L-3111-3	3.00		0,054	0,600	

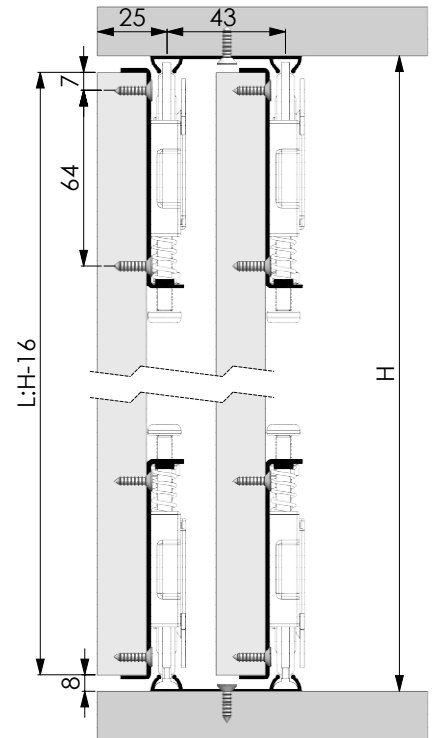

LC75 AY-UK

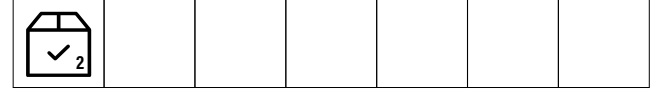
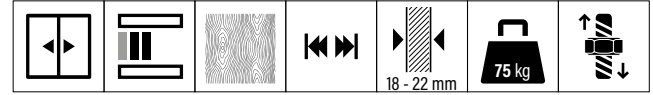

PDF

1 Set İeriđi | 1 Set Includes

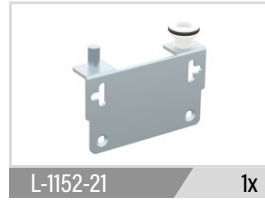
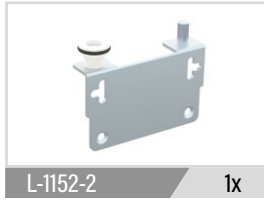
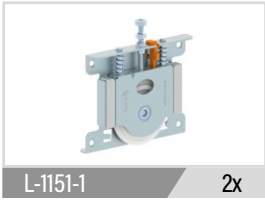

Code	T (mm)	Box	Volume (m ³)	Weight (kg)	Birim / Unit
L-1152	18-22	42	0,035	28,56	1 Tk - 1 Kapak / 1 Set - 1 Doors

Technical Drawing	Code	T (mt)	Bađ Band	Volume (m ³)	Weight (kg)	Unit
<p>Alüminyum Alt-Üst Ray / Bottom-Upper Rail</p>	L-3142-1	2.00	20	0,0096	0,4160	Adet Pcs
	L-3142-2	2.50		0,012	0,5200	
	L-3142-3	3.00		0,0144	0,6240	
<p>Alüminyum Üst Ray / Upper Rail</p>	L-3123-1	2.00	10	0,015	0,9140	Adet Pcs
	L-3123-2	2.50		0,019	1,1425	
	L-3123-3	3.00		0,023	1,3710	
<p>Alüminyum Tekli Alt-Üst Ray / Bottom-Upper Rail</p>	L-3124	3.00	20	0,015	0,6240	Adet Pcs
	L-3124-2	2.50		0,0125	0,520	

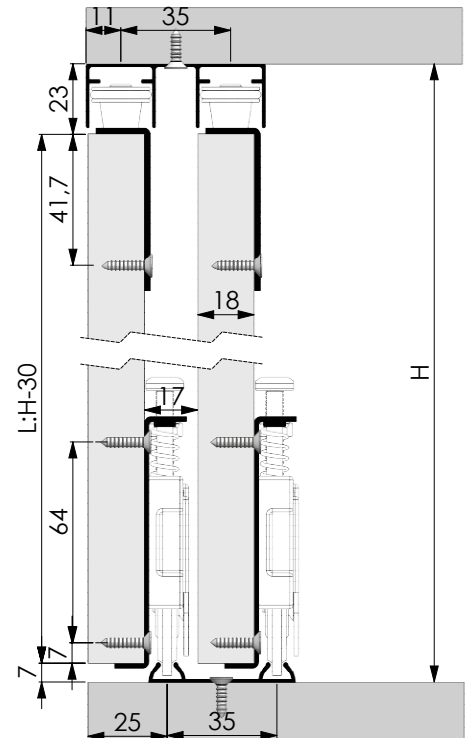

LC75 AY-LUK

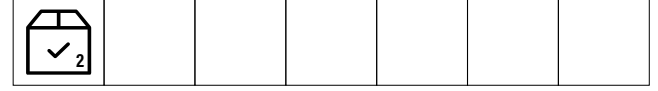
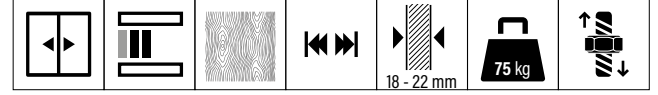

PDF

1 Set İçeriği | 1 Set Includes

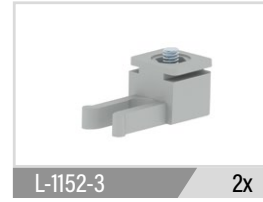
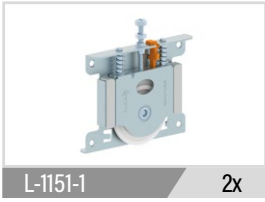

Code	T (mm)	Box	Volume (m³)	Weight (kg)	Birim / Unit
L-1154	18-22	42	0,035	23,5	1Tk-1 Kapak / 1 Set - 1 Doors

Technical Drawing	Code	T (mt)	Bağ Band	Volume (m³)	Weight (kg)	Unit
<p>Alüminyum Alt-Üst Ray / Bottom-Upper Rail</p>	L-3142-1	2.00	20	0,0096	0,4160	Adet Pcs
	L-3142-2	2.50		0,012	0,5200	
	L-3142-3	3.00		0,0144	0,6240	
<p>Alüminyum Üst Ray / Upper Rail</p>	L-3123-1	2.00	10	0,015	0,9140	Adet Pcs
	L-3123-2	2.50		0,019	1,1425	
	L-3123-3	3.00		0,023	1,3710	
<p>Alüminyum Tekli Alt-Üst Ray / Bottom-Upper Rail</p>	L-3124	3.00	20	0,015	0,6240	Adet Pcs
	L-3124-2	2.50		0,0125	0,520	

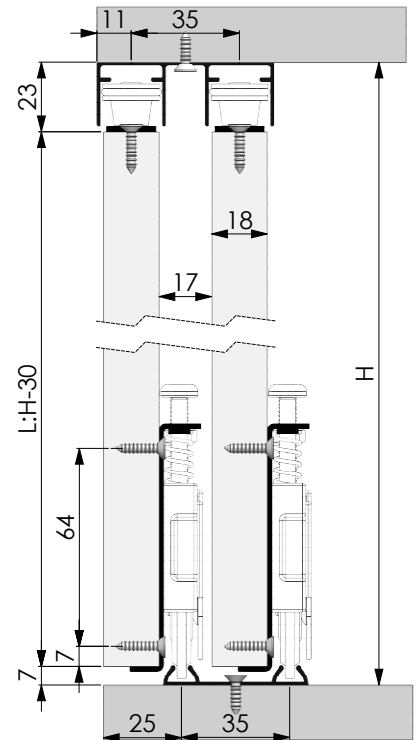

LC75 AY UK K

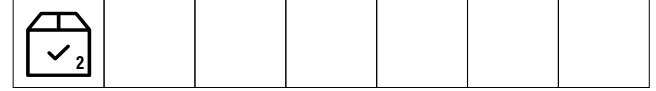
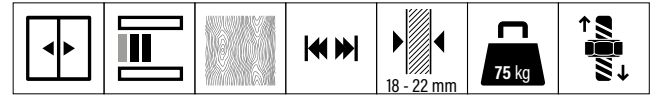

PDF

1 Set İçeriği | 1 Set Includes

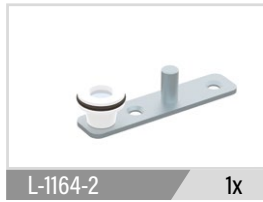
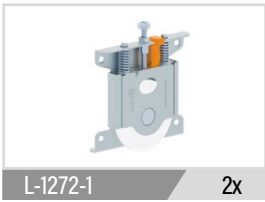

Code	T (mm)	Box	Volume (m³)	Weight (kg)	Birim / Unit
L-1153	18-22	54	0,025	20,8	1Tk - 1 Kapak / 1 Set - 1 Doors
L-1272-1	18-22	144	0,027	22,3	1 Adet / 1 Pcs

Technical Drawing	Code	T (mt)	Bağ Band	Volume (m³)	Weight (kg)	Unit
<p>Alüminyum Alt-Üst Ray / Bottom-Upper Rail</p>	L-3142-1	2.00	20	0,0096	0,4160	Adet Pcs
	L-3142-2	2.50		0,012	0,5200	
	L-3142-3	3.00		0,0144	0,6240	
<p>Alüminyum Üst Ray / Upper Rail</p>	L-3123-1	2.00	10	0,015	0,9140	Adet Pcs
	L-3123-2	2.50		0,019	1,1425	
	L-3123-3	3.00		0,023	1,3710	
<p>Alüminyum Tekli Alt-Üst Ray / Bottom-Upper Rail</p>	L-3124	3.00	20	0,015	0,6240	Adet Pcs
	L-3124-2	2.50		0,0125	0,520	

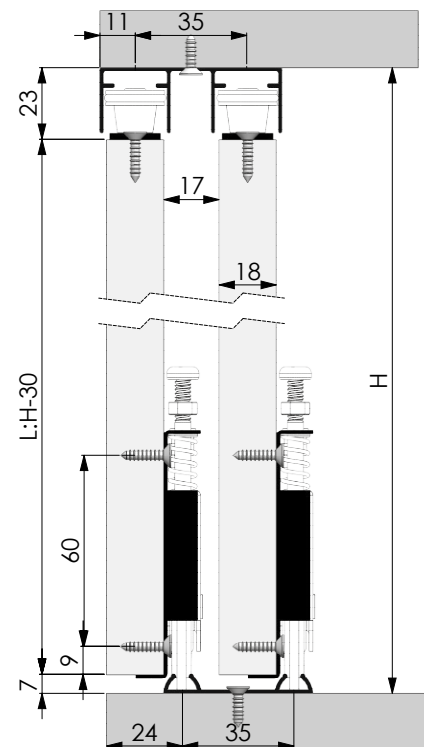

LC75 MIX ECO

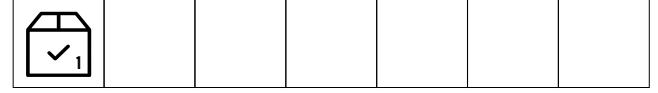
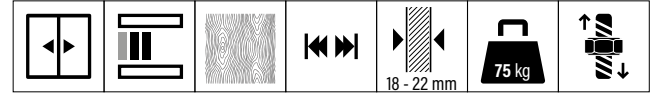

PDF

1 Set İçeriği | 1 Set Includes

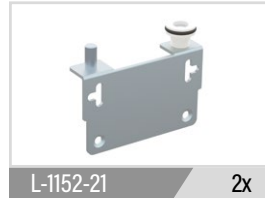
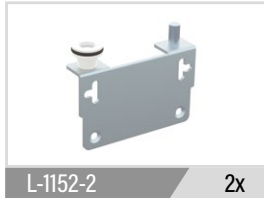
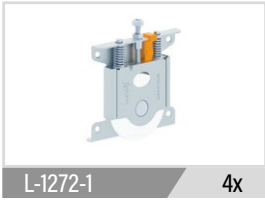

Code	T (mm)	Box	Volume (m³)	Weight (kg)	Birim / Unit
L-1159	18-22	28	0,035	28,35	1Tk - 2 Kapak / 1 Set - 2 Doors

Technical Drawing	Code	T (mt)	Bağ Band	Volume (m³)	Weight (kg)	Unit
<p>Alüminyum Alt-Üst Ray / Bottom-Upper Rail</p>	L-3142-1	2.00	20	0,0096	0,4160	Adet Pcs
	L-3142-2	2.50		0,012	0,5200	
	L-3142-3	3.00		0,0144	0,6240	
<p>Alüminyum Üst Ray / Upper Rail</p>	L-3123-1	2.00	10	0,015	0,9140	Adet Pcs
	L-3123-2	2.50		0,019	1,1425	
	L-3123-3	3.00		0,023	1,3710	
<p>Alüminyum Tekli Alt-Üst Ray / Bottom-Upper Rail</p>	L-3124	3.00	20	0,015	0,6240	Adet Pcs
	L-3124-2	2.50		0,0125	0,520	

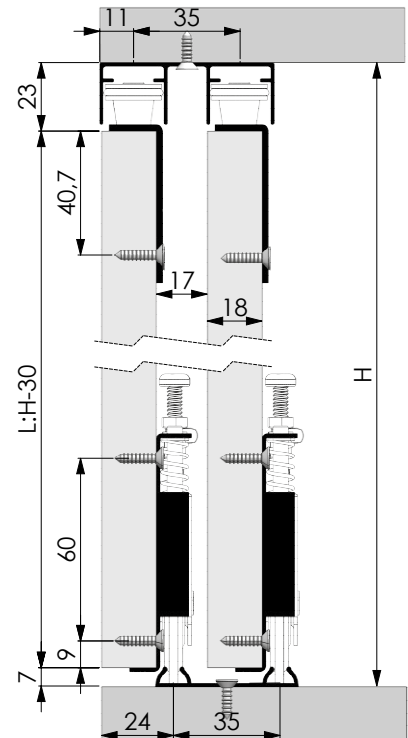

LC75 AY-SC

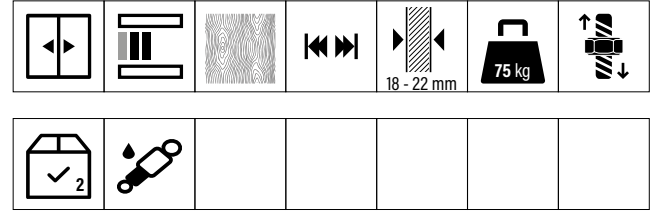

PDF

1 Set İçeriği | 1 Set Includes

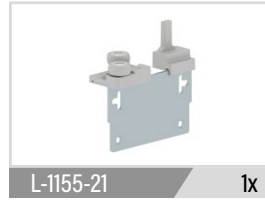
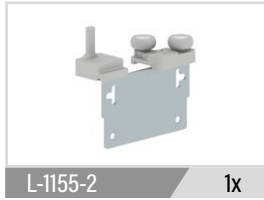
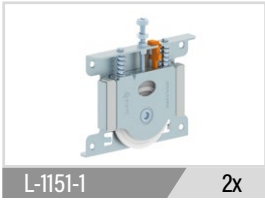

Code	T (mm)	Box	Volume (m ³)	Weight (kg)	Birim / Unit
L-1155	18-22	18	0,035	15,2	1Tk- 1Kapak / 1 Set - 1 Doors

Technical Drawing	Code	T (mm)	Bağ Band	Volume (m ³)	Weight (kg)	Unit
<p>Alüminyum Üst Ray / Upper Rail</p>	L-3145-1	2.00	6	0,0208	1,4860	Adet Pcs
	L-3145-2	2.50		0,026	1,8575	
	L-3145-3	3.00		0,0432	2,235	
<p>Alüminyum Alt Ray / Bottom Rail</p>	L-3143-1	2.00	20	0,011	0,5700	Adet Pcs
	L-3143-2	2.50		0,03	0,7125	
	L-3143-3	3.00		0,036	0,800	
<p>Alüminyum Alt Ray Kapak Profili / Aluminium Bottom Rail Cover Profile</p>	L-3144-1	2.00	40	0,0042	0,1180	Adet Pcs
	L-3144-2	2.50		0,00525	0,1475	
	L-3144-3	3.00		0,0063	0,1770	

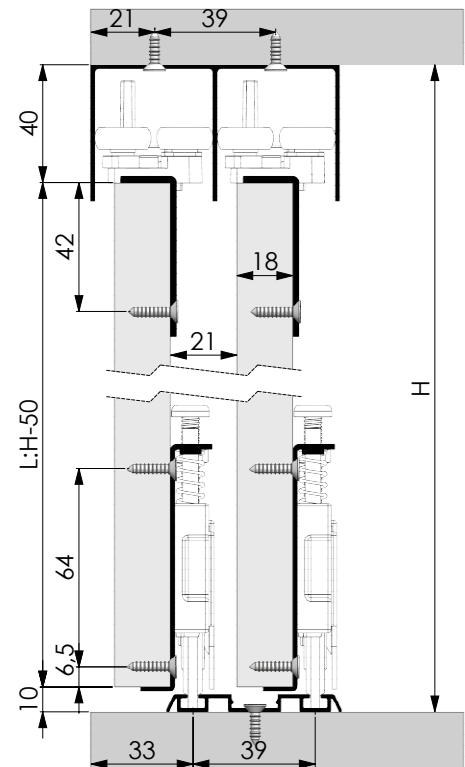



LC80 BETA RULMANSIZ / WITHOUT BALL BEARING

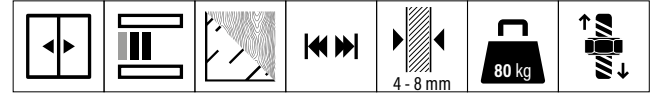

--	--	--	--	--	--



PDF

1 Set İçeriği | 1 Set Includes

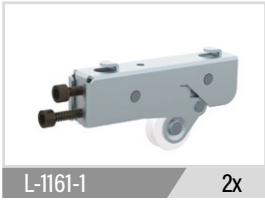

Code	T (mm)	Box	Volume (m³)	Weight (kg)	Birim / Unit
L-1161	4-8	72	0,027	22,3	1Tk - 1 Kapak / 1 Set - 1 Doors

LC80 GAMA RULMANSIZ / WITHOUT BALL BEARING

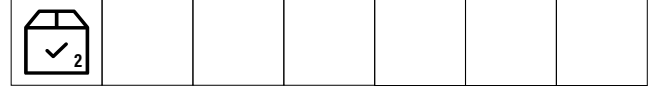
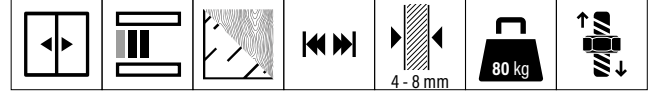

PDF

1 Set İçeriği | 1 Set Includes

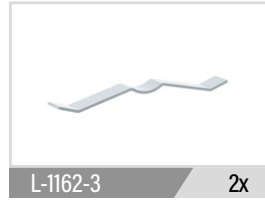
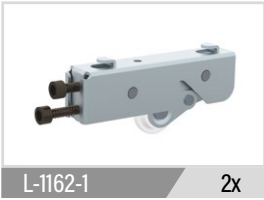

Code	T (mm)	Box	Volume (m³)	Weight (kg)	Birim / Unit
L-1162	4-8	72	0,027	22,3	1Tk - 1 Kapak / 1 Set - 1 Doors



LC80 BETA RULMANLI / WITH BALL BEARING

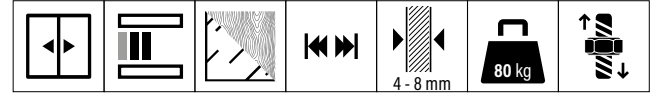

--	--	--	--	--	--	--



PDF

1 Set İçeriği | 1 Set Includes

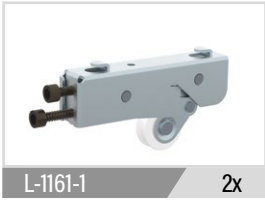

Code	T (mm)	Box	Volume (m³)	Weight (kg)	Birim / Unit
L-1165	4-8	72	0,027	22,3	1Tk - 1 Kapak / 1 Set - 1 Doors

LC80 GAMA RULMANLI / WITH BALL BEARING

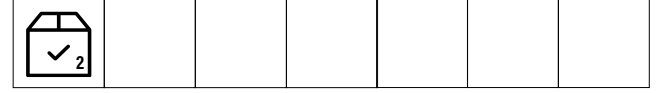
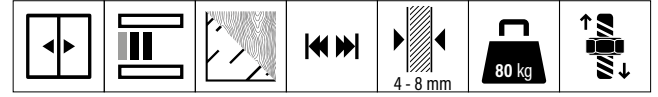

PDF

1 Set İeriđi | 1 Set Includes

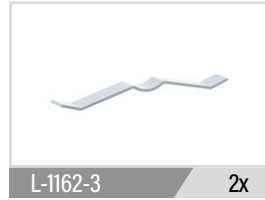
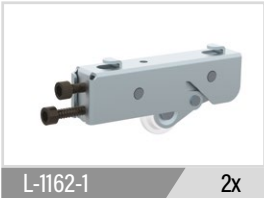

Code	T (mm)	Box	Volume (m ³)	Weight (kg)	Birim / Unit
L-1166	4-8	72	0,027	22,3	1Tk - 1Kapak / 1Set - 1Doors

LC80 VEGA

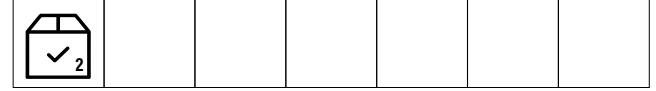
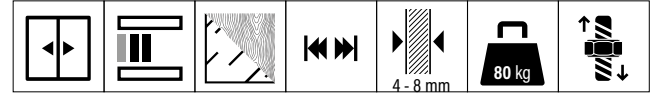

PDF

1 Set İçeriği | 1 Set Includes

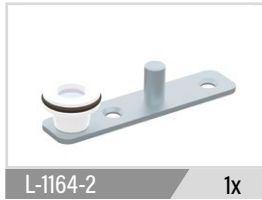

Code	T (mm)	Box	Volume (m³)	Weight (kg)	Birim / Unit
L-1164	4-8	72	0,027	14	1 Tk - 1 Kapak / 1 Set - 1 Doors

Technical Drawing	Code	T (mm)	Bağ Band	Volume (m³)	Weight (kg)	Unit
<p>Alüminyum Alt-Üst Ray / Bottom-Upper Rail</p>	L-3142-1	2.00	20	0,0096	0,4160	Adet Pcs
	L-3142-2	2.50		0,012	0,5200	
	L-3142-3	3.00		0,0144	0,6240	
<p>Alüminyum Üst Ray / Upper Rail</p>	L-3123-1	2.00	10	0,015	0,9140	Adet Pcs
	L-3123-2	2.50		0,019	1,1425	
	L-3123-3	3.00		0,023	1,3710	
<p>Alüminyum Tekli Alt-Üst Ray / Bottom-Upper Rail</p>	L-3124	3.00	20	0,015	0,6240	Adet Pcs
	L-3124-2	2.50		0,0125	0,520	

LC85

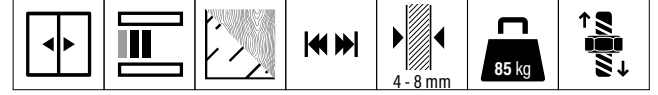

--	--	--	--	--	--	--



PDF

1 Set İçeriği | 1 Set Includes

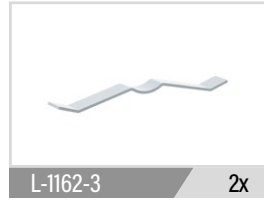

Code	T (mm)	Box	Volume (m³)	Weight (kg)	Birim / Unit
L-1171	4-8	72	0,027	20	1Tk - 1 Kapak / 1 Set - 1 Doors



LC87

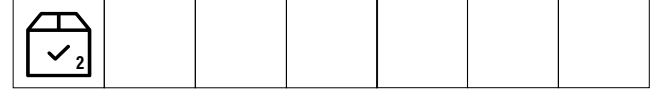
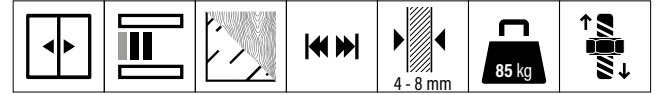

PDF

1 Set İçeriği | 1 Set Includes

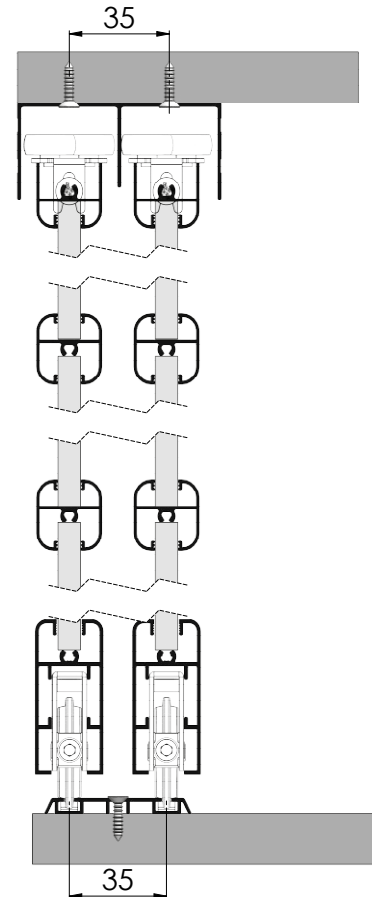
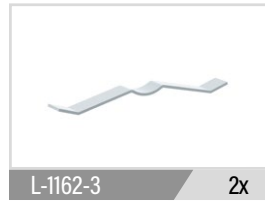

Code	T (mm)	Box	Volume (m³)	Weight (kg)	Birim / Unit
L-1173	4-8	72	0,027	16	1Tk - 1 Kapak / 1 Set - 1 Doors

LC70 AY

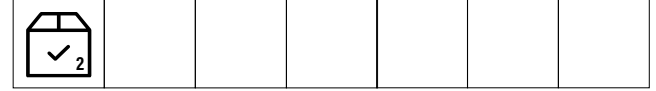
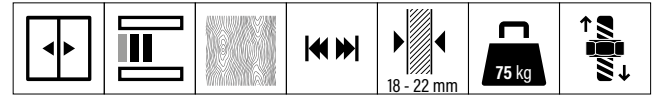

PDF

1 Set İçeriği | 1 Set Includes

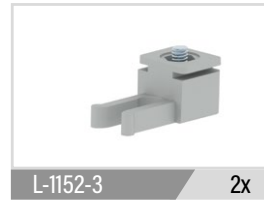
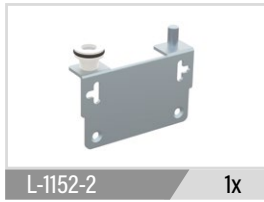

Code	T (mm)	Box	Volume (m ³)	Weight (kg)	Birim / Unit
L-1181	18-22	56	0,035	28,45	1Tk -1 Kapak / 1 Set - 1 Doors

Technical Drawing	Code	T (mm)	Bağ Band	Volume (m ³)	Weight (kg)	Unit
<p>Alüminyum Üst Ray / Upper Rail</p>	L-3123-1	2.00	10	0,015	0,9140	Adet Pcs
	L-3123-2	2.50		0,019	1,1425	
	L-3123-3	3.00		0,023	1,3710	
<p>Alüminyum Tekli Alt-Üst Ray / Bottom-Upper Rail</p>	L-3124	3.00	20	0,015	0,524	Adet Pcs
	L-3124-2	2.50		0,0125	0,520	
<p>Alüminyum Alt-Üst Ray / Bottom-Upper Rail</p>	L-3142-1	2.00	20	0,0096	0,4160	Adet Pcs
	L-3142-2	2.50		0,012	0,5200	
	L-3142-3	3.00		0,0144	0,6240	

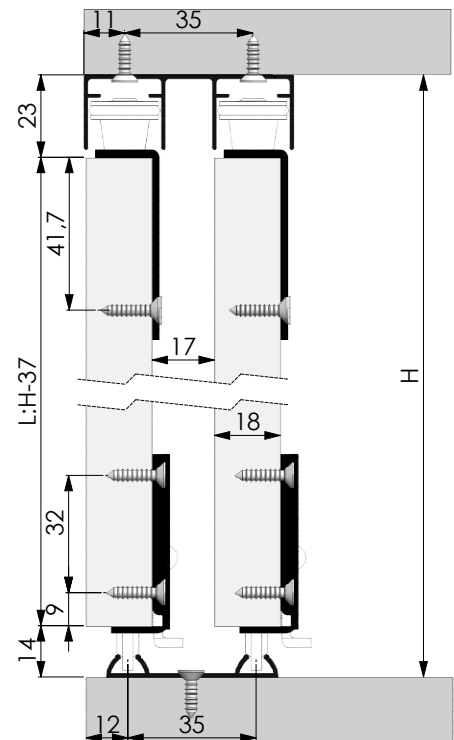



LC80 AY

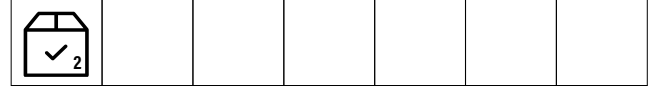
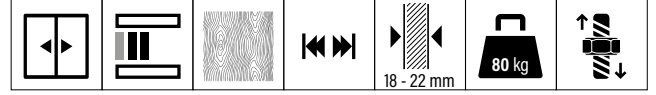

PDF

1 Set İçeriği | 1 Set Includes

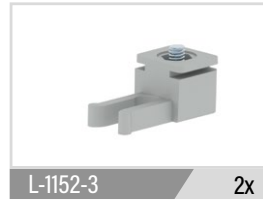
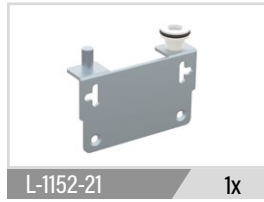
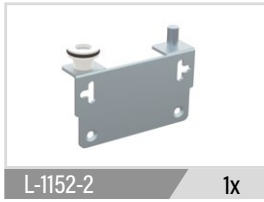
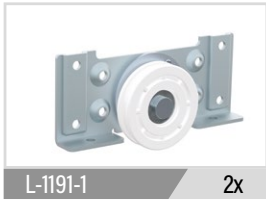

Code	T (mm)	Box	Volume (m³)	Weight (kg)	Birim / Unit
L-1191	18-22	56	0,035	29,5	1Tk-1 Kapak / 1 Set - 1 Doors

Technical Drawing	Code	T (mm)	Bağ Band	Volume (m³)	Weight (kg)	Unit
<p>Alüminyum Üst Ray / Upper Rail</p>	L-3123-1	2.00	10	0,015	0,9140	Adet Pcs
	L-3123-2	2.50		0,019	1,1425	
	L-3123-3	3.00		0,023	1,3710	
<p>Alüminyum Tekli Alt-Üst Ray / Bottom-Upper Rail</p>	L-3124	3.00	10	0,015	0,6240	Adet Pcs
	L-3124-2	2.50		0,0125	0,520	
<p>Alüminyum Alt Ray / Bottom Rail</p>	L-3125-1	2.00	20	0,013	0,5260	Adet Pcs
	L-3125-2	2.50		0,01625	0,6575	
	L-3125-3	3.00		0,0195	0,7890	
<p>Alüminyum Alt-Üst Ray / Bottom-Upper Rail</p>	L-3106	3.00	20	0,03375	0,300	Adet Pcs

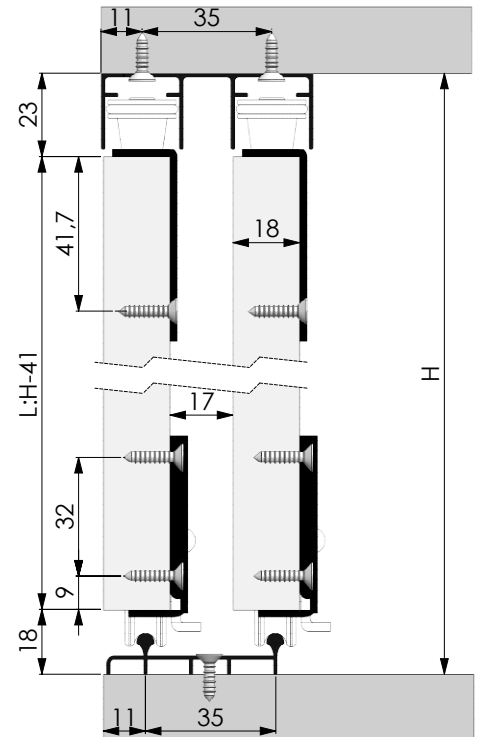

LC80 AYS

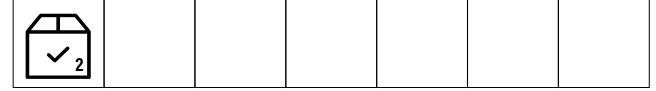
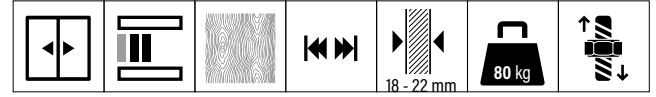

PDF

1 Set İçeriği | 1 Set Includes

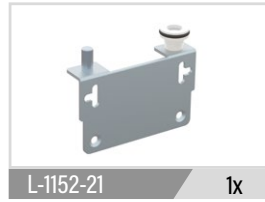
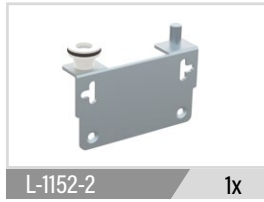

Code	T (mm)	Box	Volume (m³)	Weight (kg)	Birim / Unit
L-1192	18-22	56	0,035	24	1Tk - 1 Kapak / 1 Set - 1 Doors

Technical Drawing	Code	T (mm)	Bağ Band	Volume (m³)	Weight (kg)	Unit
<p>Alüminyum Üst Ray / Upper Rail</p>	L-3123-1	2.00	10	0,015	0,9140	Adet Pcs
	L-3123-2	2.50		0,019	1,1425	
	L-3123-3	3.00		0,023	1,3710	
<p>Alüminyum Tekli Alt-Üst Ray / Bottom-Upper Rail</p>	L-3124	3.00	10	0,015	0,6240	Adet Pcs
	L-3124-2	2.50		0,0125	0,520	
<p>Alüminyum Alt Ray / Bottom Rail</p>	L-3125-1	2.00	20	0,013	0,5260	Adet Pcs
	L-3125-2	2.50		0,01625	0,6575	
	L-3125-3	3.00		0,0195	0,7890	
<p>Alüminyum Alt-Üst Ray / Bottom-Upper Rail</p>	L-3106	3.00	20	0,03375	0,300	Adet Pcs

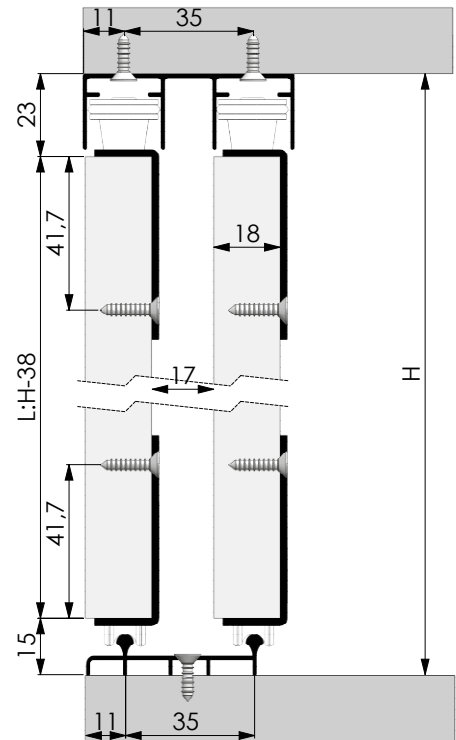

LC57

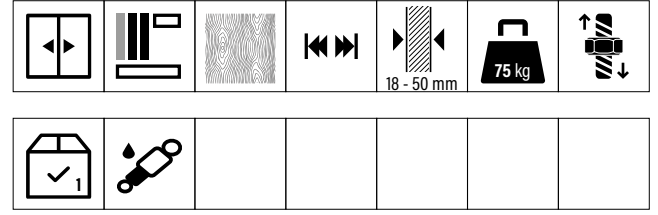

PDF

1 Set İçeriği | 1 Set Includes

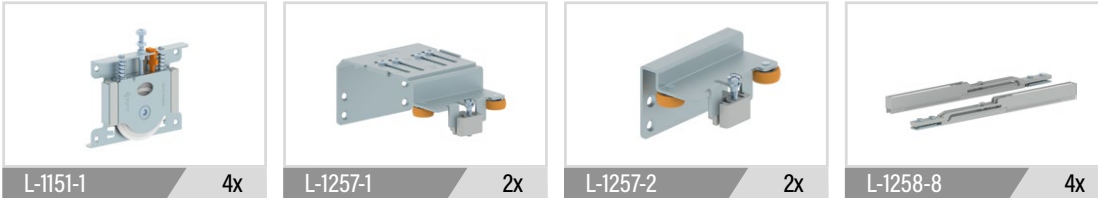

Code	T (mm)	Box	Volume (m³)	Weight (kg)	Birim / Unit
L-1257	18-50	8	0,035	178	1Tk - 2 Kapak / 1 Set - 2 Doors
L-1262	18-50	8	0,035	23,4	1Tk - 3 Kapak / 1 Set - 3 Doors

Technical Drawing	Code	T (mt)	Bağ Band	Volume (m³)	Weight (kg)	Unit
<p>Alüminyum Üst Ray / Upper Rail</p>	L-3174-1	2.00	6	0,0208	1,588	Adet Pcs
	L-3174-2	2.50		0,0260	1,985	
	L-3174-3	3.00		0,0312	2,382	
<p>Alüminyum Alt Ray / Bottom Rail</p>	L-3143-1	2.00	20	0,011	0,5700	Adet Pcs
	L-3143-2	2.50		0,03	0,7125	
	L-3143-3	3.00		0,036	0,800	
<p>Alüminyum Alt Ray Kapak Profili / Bottom Rail Cover Profile</p>	L-3144-1	2.00	40	0,0042	0,1180	Adet Pcs
	L-3144-2	2.50		0,00525	0,1475	
	L-3144-3	3.00		0,0063	0,1770	
<p>Alüminyum Alt-Üst Ray / Bottom-Upper Rail</p>	L-3110-1	2.00	20	0,024	0,500	Adet Pcs
	L-3110-2	2.50		0,03	0,600	
	L-3110-3	3.00		0,036	0,700	

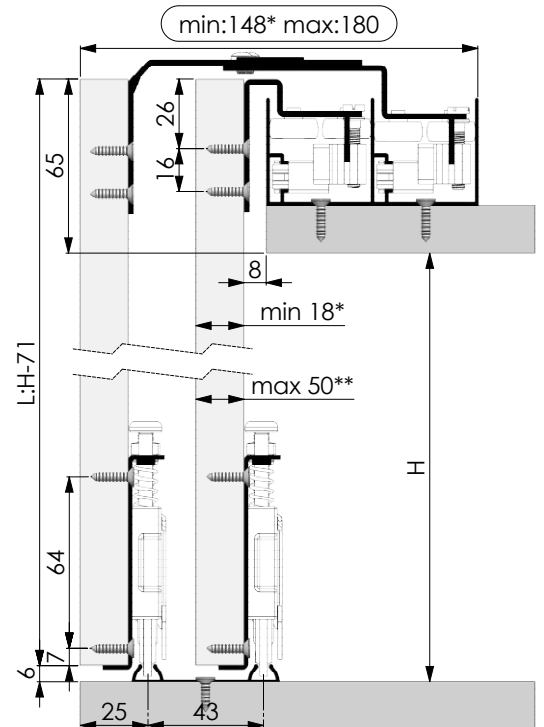

LC57 ECO

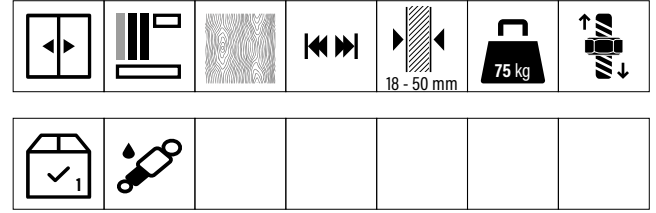

PDF

1 Set İçeriği | 1 Set Includes

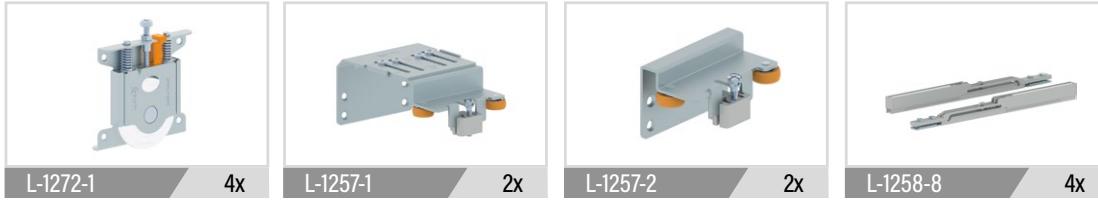

Code	T (mm)	Box	Volume (m ³)	Weight (kg)	Birim / Unit
L-1268	18-50	8	0,035	14,6	1Tk - 2 Kapak / 1 Set - 2 Doors
L-1269	18-50	8	0,035	19,5	1Tk - 3 Kapak / 1 Set - 3 Doors

Technical Drawing	Code	T (mt)	Bağ Band	Volume (m ³)	Weight (kg)	Unit
<p>Alüminyum Üst Ray / Upper Rail</p>	L-3174-1	2.00	6	0,0208	1,588	Adet Pcs
	L-3174-2	2.50		0,0260	1,985	
	L-3174-3	3.00		0,0312	2,382	
<p>Alüminyum Alt Ray / Bottom Rail</p>	L-3143-1	2.00	20	0,011	0,5700	Adet Pcs
	L-3143-2	2.50		0,03	0,7125	
	L-3143-3	3.00		0,036	0,800	
<p>Alüminyum Alt Ray Kapak Profili / Bottom Rail Cover Profile</p>	L-3144-1	2.00	40	0,0042	0,1180	Adet Pcs
	L-3144-2	2.50		0,00525	0,1475	
	L-3144-3	3.00		0,0063	0,1770	
<p>Alüminyum Alt-Üst Ray / Bottom-Upper Rail</p>	L-3110-1	2.00	20	0,024	0,500	Adet Pcs
	L-3110-2	2.50		0,03	0,600	
	L-3110-3	3.00		0,036	0,700	

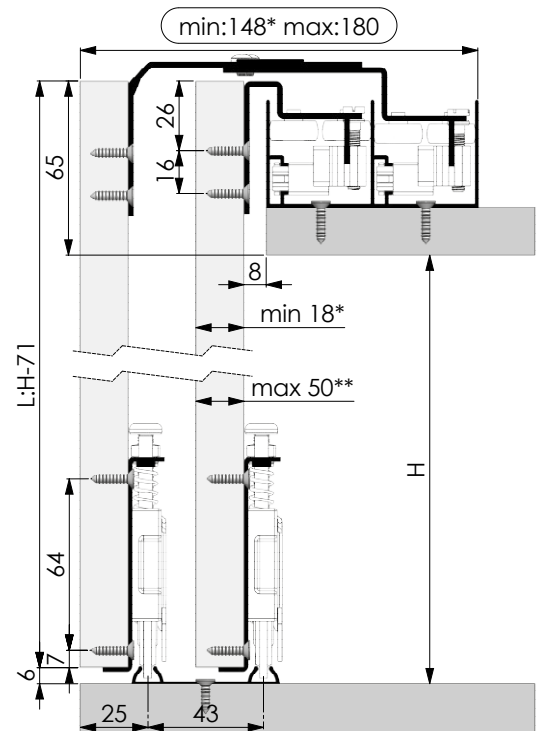

LC58

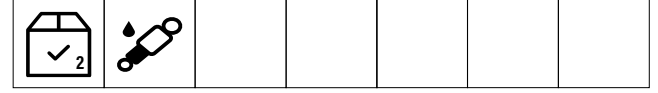
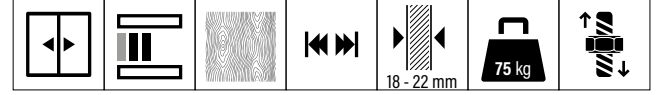

PDF

1 Set İçeriği | 1 Set Includes

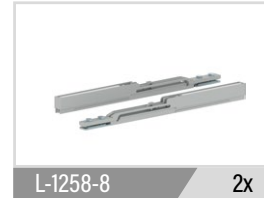
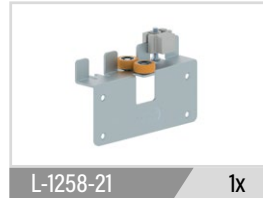
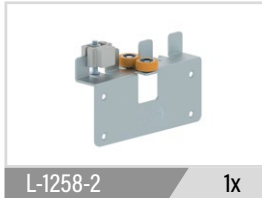
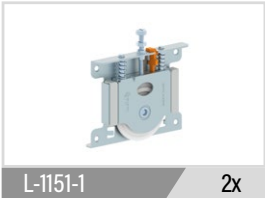

Code	T (mm)	Box	Volume (m³)	Weight (kg)	Birim / Unit
L-1258	18-22	18	0,035	16,2	1 Tk - 1 Kapak / 1 Set - 1 Doors

Technical Drawing	Code	T (mt)	Bağ Band	Volume (m³)	Weight (kg)	Unit
<p>Alüminyum Üst Ray / Upper Rail</p>	L-3174-1	2.00	6	0,0208	1,588	Adet Pcs
	L-3174-2	2.50		0,0260	1,985	
	L-3174-3	3.00		0,0312	2,382	
<p>Alüminyum Alt Ray / Bottom Rail</p>	L-3143-1	2.00	20	0,011	0,5700	Adet Pcs
	L-3143-2	2.50		0,03	0,7125	
	L-3143-3	3.00		0,036	0,8	
<p>Alüminyum Alt Ray Kapak Profili / Bottom Rail Cover Profile</p>	L-3144-1	2.00	40	0,0042	0,1180	Adet Pcs
	L-3144-2	2.50		0,00525	0,1475	
	L-3144-3	3.00		0,0063	0,1770	

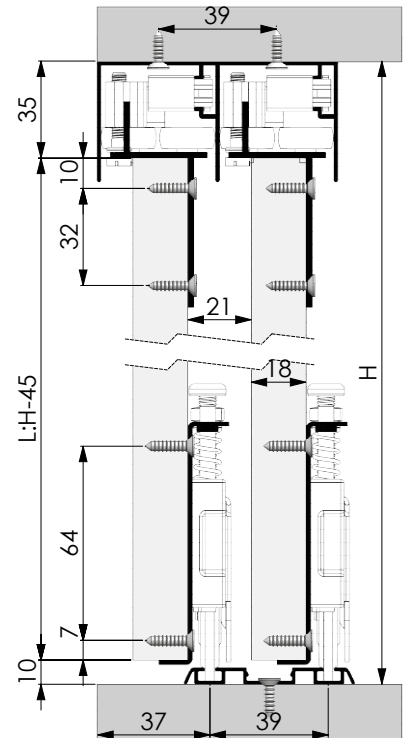

LC75 AY-YLUK

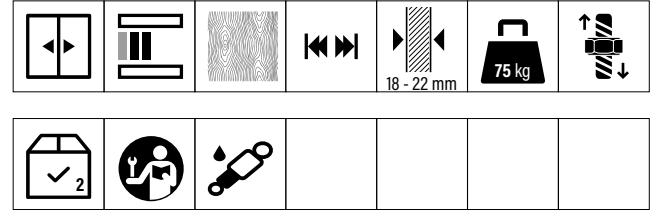

PDF

1 Set İçeriği | 1 Set Includes

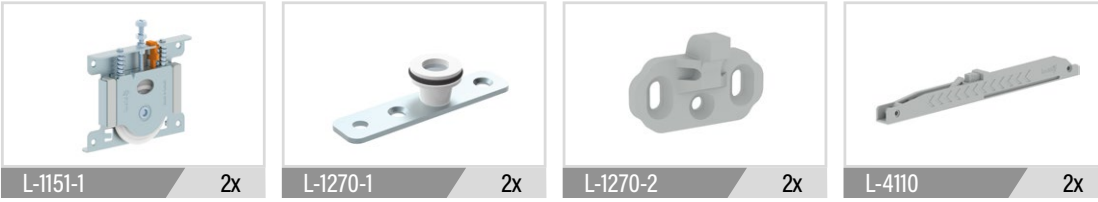

Code	T (mm)	Box	Volume (m³)	Weight (kg)	Birim / Unit
L-1270	18-22	24	0,035	17	1Tk-1 Kapak / 1 Set - 1 Doors

Technical Drawing	Code	T (mt)	Bağ Band	Volume (m³)	Weight (kg)	Unit
<p>Alüminyum Üst Ray / Upper Rail</p>	L-3110-1	2.00	20	0,024	0,500	Adet Pcs
	L-3110-2	2.50		0,03	0,600	
	L-3110-3	3.00		0,036	0,700	
<p>Alüminyum Üst Ray / Upper Rail</p>	L-3178-1	2.00	10	0,015	0,976	Adet Pcs
	L-3178-3	3.00		0,023	1,464	

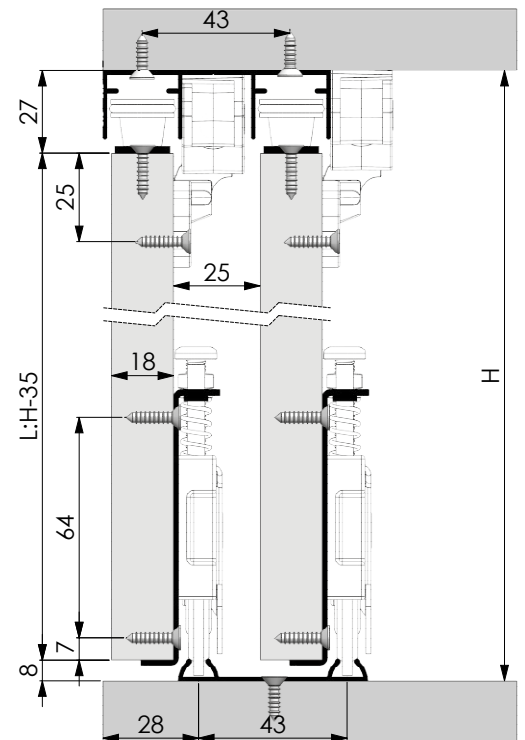

LC75 AY-YLUK-ECO

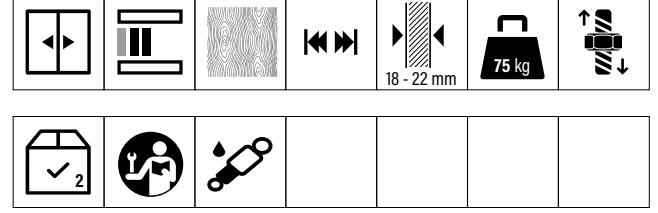

PDF

1 Set İçeriği | 1 Set Includes

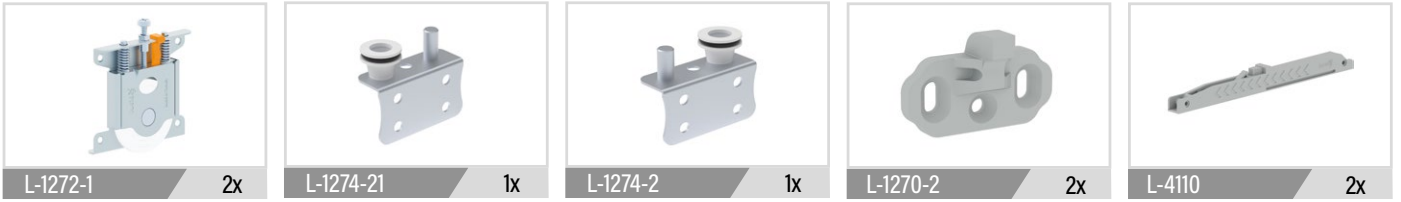

Code	T (mm)	Box	Volume (m³)	Weight (kg)	Birim / Unit
L-1271	18-22	24	0,035	13	1Tk-1Kapak / 1Set-1Doors

Technical Drawing	Code	T (mt)	Bağ Band	Volume (m³)	Weight (kg)	Unit
<p>Alüminyum Üst Ray / Upper Rail</p>	L-3110-1	2.00	20	0,024	0,500	Adet Pcs
	L-3110-2	2.50		0,03	0,600	
	L-3110-3	3.00		0,036	0,700	
<p>Alüminyum Üst Ray / Upper Rail</p>	L-3178-1	2.00	10	0,015	0,976	Adet Pcs
	L-3178-3	3.00		0,023	1,464	

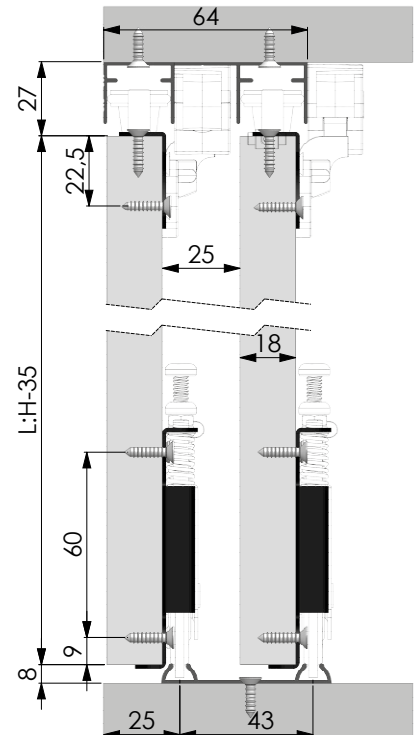

LC75 AY-UK-ECO

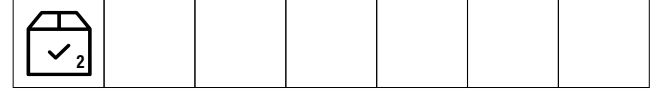
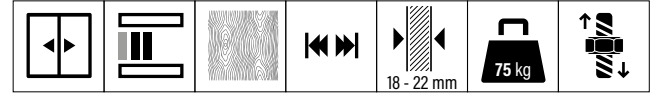

PDF

1 Set İÇeriği | 1 Set Includes

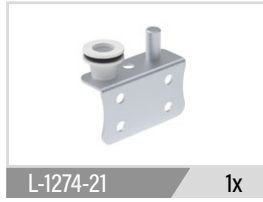

Code	T (mm)	Box	Volume (m³)	Weight (kg)	Birim / Unit
L-1274	18-22	54	0,025	21	1Tk - 1 Kapak / 1 Set - 1 Doors

Technical Drawing	Code	T (mt)	Bağ Band	Volume (m³)	Weight (kg)	Unit
<p>Alüminyum Üst Ray / Upper Rail</p>	L-3110-1	2.00	20	0,024	0,500	Adet Pcs
	L-3110-2	2.50		0,03	0,600	
	L-3110-3	3.00		0,036	0,700	
<p>Alüminyum Üst Ray / Upper Rail</p>	L-3123-1	2.00	10	0,015	0,9140	Adet Pcs
	L-3123-2	2.50		0,019	1,1425	
	L-3123-3	3.00		0,023	1,3710	

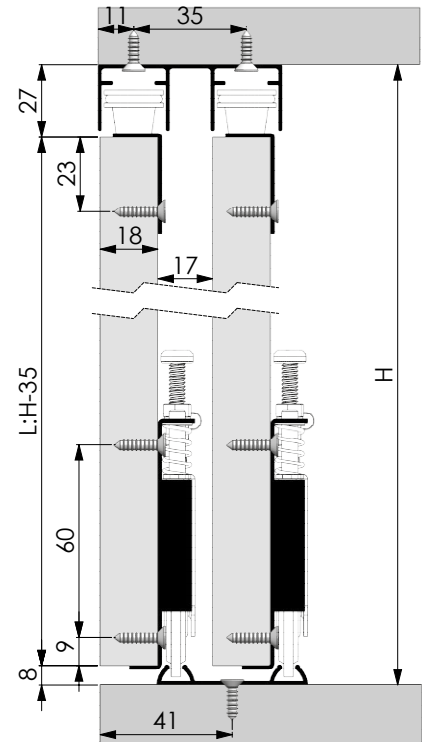

Sliding Door Systems

Sürme Kapı Sistemleri







LC65 ÜSTTEN MONTAJ / UPPER MOUNTED

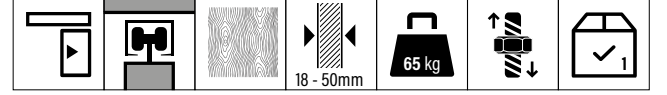

PDF

1 Set İçeriği | 1 Set Includes

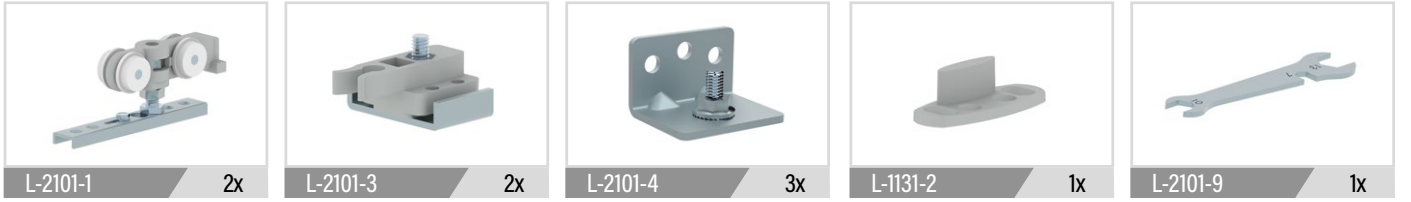

Code	T (mm)	Box	Volume (m³)	Weight (kg)	Birim / Unit
L-2101	18-50	36	0,027	16,7	1Tk-1Kapak/1 Set-1 Doors

Technical Drawing	Code	T (mt)	Bağ Band	Volume (m³)	Weight (kg)	Unit
<p>Alüminyum Üst Ray / Upper Rail</p>	L-3127-1	2.00	10	0,0245	0,900	Adet Pcs
	L-3127-3	3.00		0,0288	1,602	
<p>PVC Alt Ray / Bottom Rail</p>	L-3703	3.00	50	0,0225	0,200	Adet Pcs

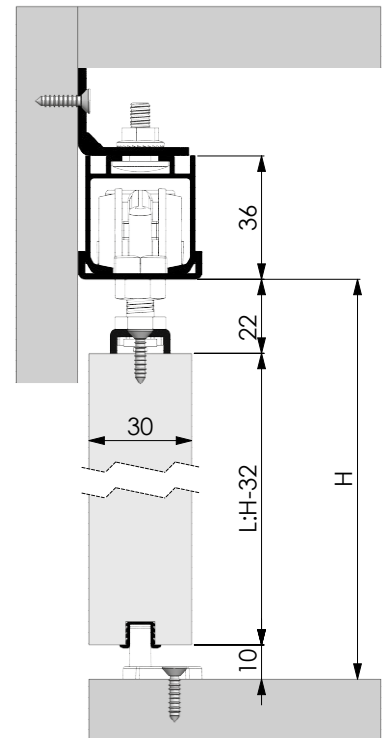

LC65 YANDAN MONTAJ / SIDE MOUNTED

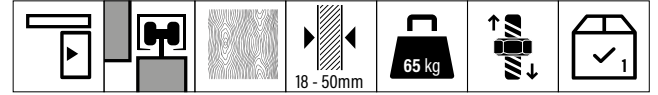

PDF

1 Set İçeriği | 1 Set Includes

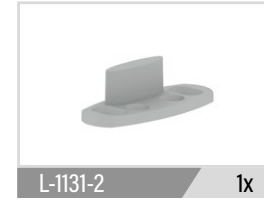
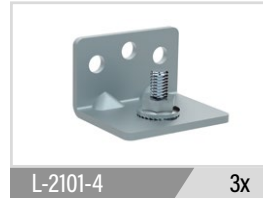
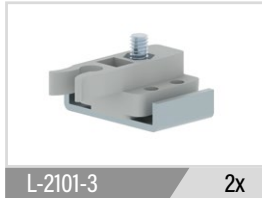
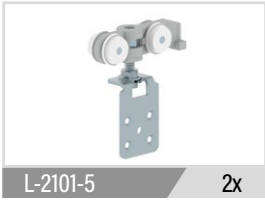

Code	T (mm)	Box	Volume (m ³)	Weight (kg)	Birim / Unit
L-2102	18-50	36	0,027	16,7	1Tk-1 Kapak / 1 Set - 1 Doors

Technical Drawing	Code	T (mt)	Bağ Band	Volume (m ³)	Weight (kg)	Unit
<p>Alüminyum Üst Ray / Upper Rail</p>	L-3127-1	2.00	10	0,0245	0,900	Adet Pcs
	L-3127-3	3.00		0,0288	1,602	
<p>PVC Alt Ray / Bottom Rail</p>	L-3703	3.00	50	0,0225	0,200	Adet Pcs

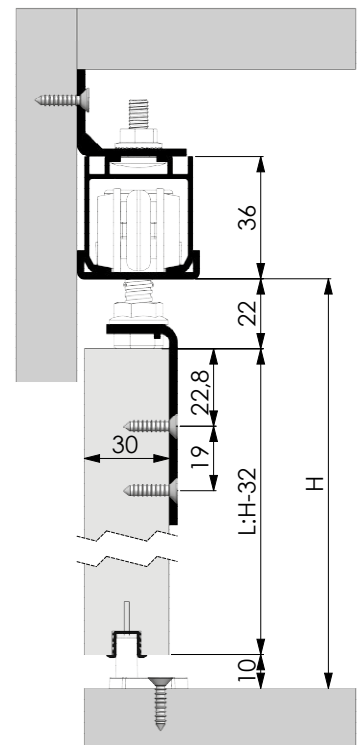



LC99 ÜSTTEN MONTAJ / UPPER MOUNTED

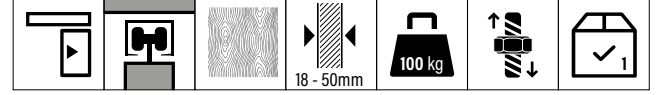

PDF

1 Set İçeriği | 1 Set Includes

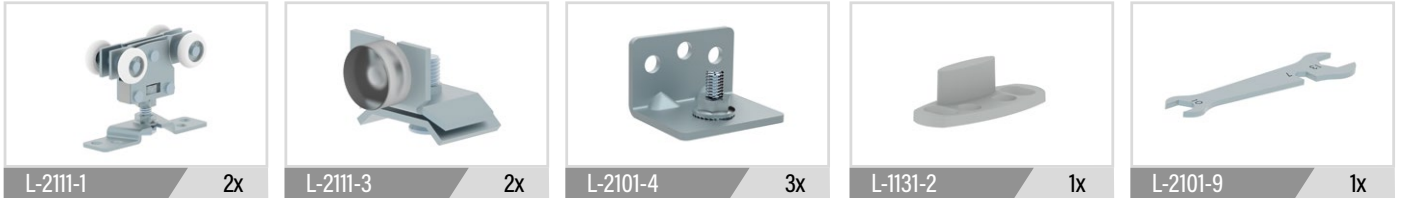

Code	T (mm)	Box	Volume (m³)	Weight (kg)	Birim / Unit
L-2111	18-50	36	0,027	27,16	1 Tk - 1 Kapak / 1 Set - 1 Doors

Technical Drawing	Code	T (mt)	Bağ Band	Volume (m³)	Weight (kg)	Unit
<p>Alüminyum Üst Ray / Upper Rail</p>	L-3128-1	2.00	10	0,405	1,100	Adet Pcs
	L-3128-3	3.00		0,06075	1,700	
<p>PVC Alt Ray / Bottom Rail</p>	L-3703	3.00	50	0,0225	0,200	Adet Pcs

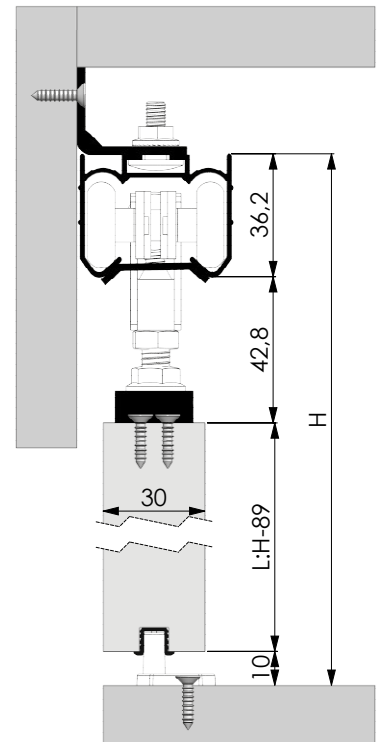

LC99 YANDAN MONTAJ / SIDE MOUNTED

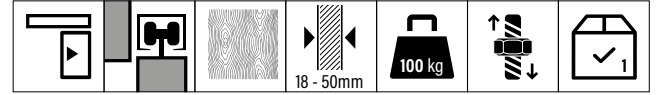

PDF

1 Set İeriđi | 1 Set Includes

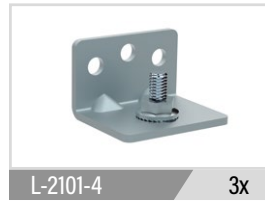
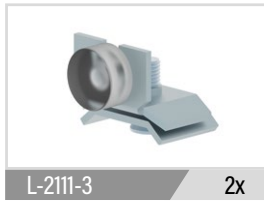

Code	T (mm)	Box	Volume (m ³)	Weight (kg)	Birim / Unit
L-2112	18-50	36	0,027	27,16	1Tk-1 Kapak / 1 Set - 1 Doors

Technical Drawing	Code	T (mt)	Bađ Band	Volume (m ³)	Weight (kg)	Unit
<p>Alüminyum Üst Ray / Upper Rail</p>	L-3128-1	2.00	10	0,405	1,100	Adet Pcs
	L-3128-3	3.00		0,06075	1,700	
<p>PVC Alt Ray / Bottom Rail</p>	L-3703	3.00	50	0,0225	0,200	Adet Pcs

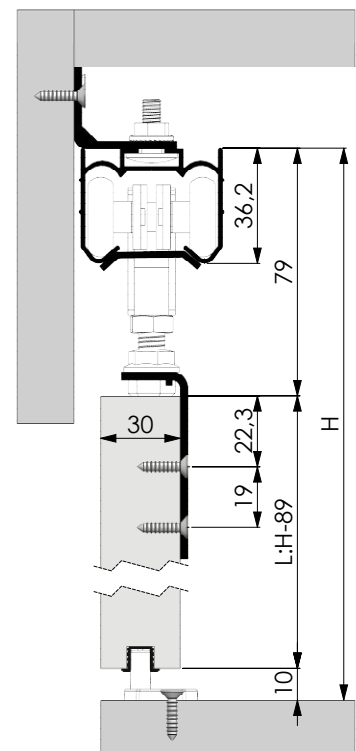



LC100 ÇİFT YAVAŞLATICI / WITH DOUBLE SOFT CLOSING

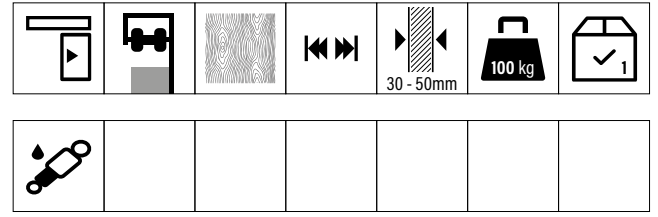

1 Set İçeriği | 1 Set Includes

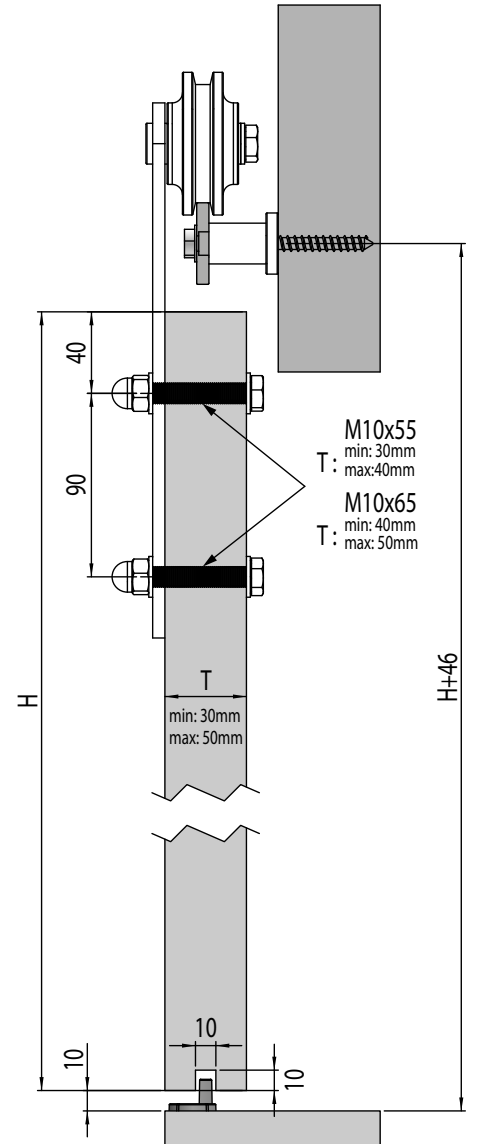

Code	T (mm)	Box	Volume (m³)	Weight (kg)	Birim / Unit
L-2131	30-50	1	0,0162	7,6	1Tk - 1 Kapı / 1 Set - 1 Door



LC122

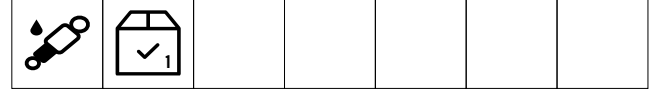
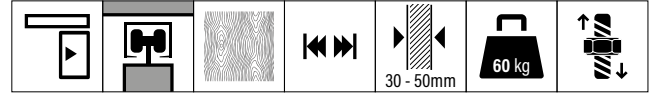

Bilgi / Information: Minimum Kapak Geniřlięi 60cm

1 Set İerięi | 1 Set Includes

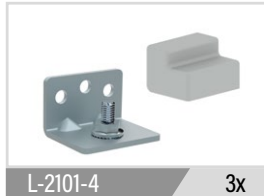
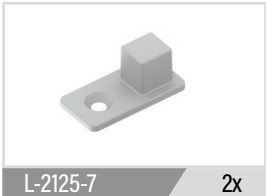
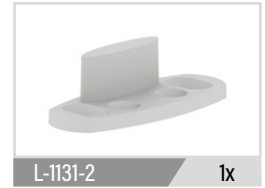

Code	T (mm)	Box	Volume (m ³)	Weight (kg)	Birim / Unit
L-2125	30-50	20	0,039	15,4	1Tk - 1 Kapak / 1 Set - 1 Doors

Teknik Çizim / Technical Drawing	Code	T (mm)	Baę Band	Volume (m ³)	Weight (kg)	Unit
<p>Alüminyum Üst Ray / Upper Rail</p>	L-3175-1	2.00	8	0,0216	2,232	Adet Pcs
	L-3175-3	3.00		0,0324	3,348	
	L-3175-4	4.00		0,0432	4,464	
<p>Alüminyum Alt Ray / Bottom Rail</p>	L-3176-1	2.00	10	0,0162	0,768	Adet Pcs
	L-3176-3	3.00		0,0243	1,152	
<p>PVC Alt Ray / Bottom Rail</p>	L-3703	3.00	50	0,0225	0,200	Adet Pcs

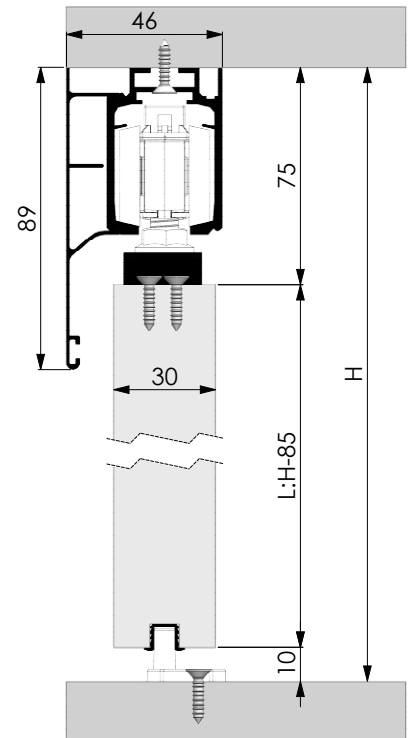



LC120 TEK YAVAŞLATICI / WITH SINGLE SOFT CLOSING

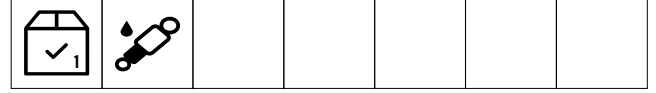
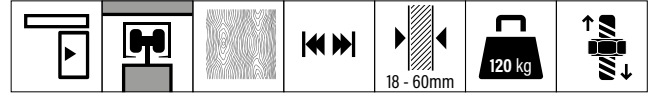

Bilgi / Information: Minimum Kapak Geniřlięi 60cm



PDF

1 Set İerięi | 1 Set Includes

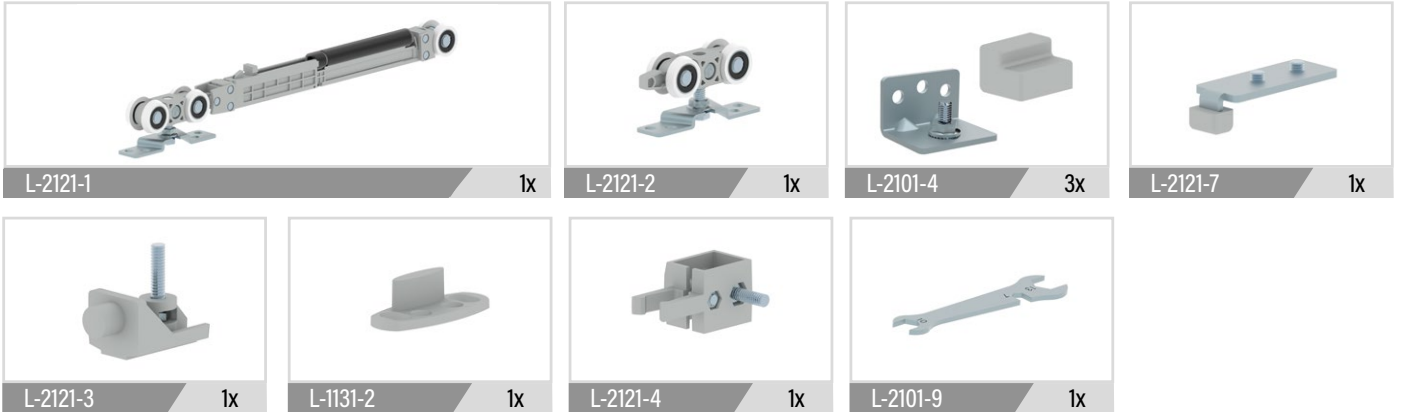

Code	T (mm)	Box	Volume (m ³)	Weight (kg)	Birim / Unit
L-2121	18-60	20	0,063	16,4	1Tk - 1 Kapak / 1 Set - 1 Doors

Technical Drawing	Code	T (mt)	Baę Band	Volume (m ³)	Weight (kg)	Unit
<p>Alüminyum Üst Ray / Upper Rail</p>	L-3175-1	2.00	8	0,0216	2,232	Adet Pcs
	L-3175-3	3.00		0,0324	3,348	
	L-3175-4	4.00		0,0432	4,464	
<p>Alm. Üst Ray Kapak / Upper Rail Cover</p>	L-3176-1	2.00	10	0,0162	0,768	Adet Pcs
	L-3176-3	3.00		0,0243	1,152	
<p>PVC Alt Ray / Bottom Rail</p>	L-3703	3.00	50	0,0225	0,200	Adet Pcs

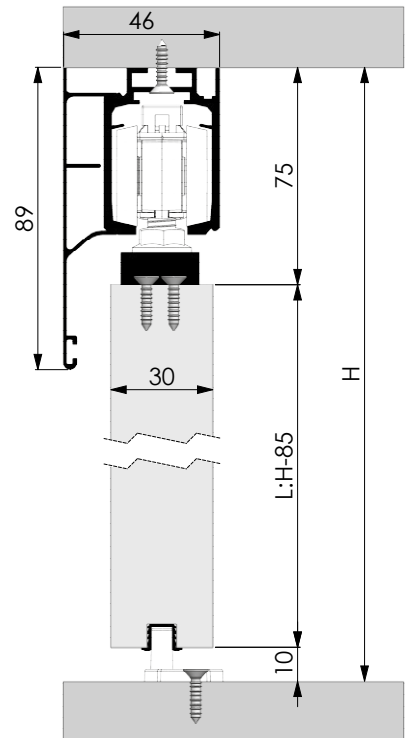

LC120 ÇİFT YAVAŞLATICI / WITH DOUBLE SOFT CLOSING

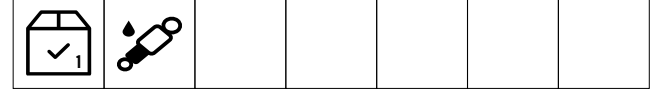
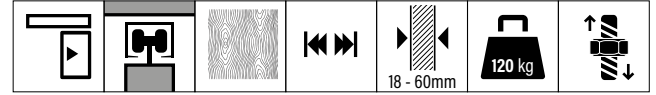

Bilgi / Information: Minimum Kapak Geniřlięi 90cm



PDF

1 Set İerięi | 1 Set Includes

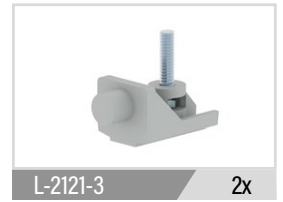
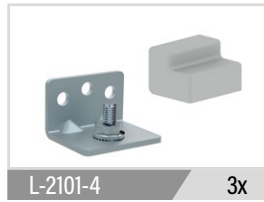
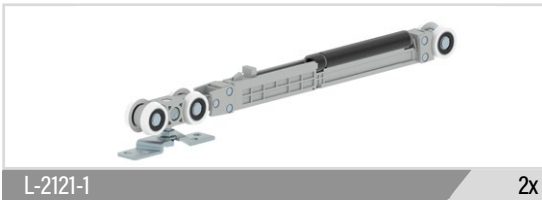

Code	T (mm)	Box	Volume (m ³)	Weight (kg)	Birim / Unit
L-2122	18-60	20	0,063	18,9	1Tk - 1 Kapak / 1 Set - 1 Doors

Technical Drawing	Code	T (mt)	Baę Band	Volume (m ³)	Weight (kg)	Unit
<p>Alüminyum Üst Ray / Upper Rail</p>	L-3175-1	2.00	8	0,0216	2,232	Adet Pcs
	L-3175-3	3.00		0,0324	3,348	
	L-3175-4	4.00		0,0432	4,464	
<p>Alm. Üst Ray Kapak / Upper Rail Cover</p>	L-3176-1	2.00	10	0,0162	0,768	Adet Pcs
	L-3176-3	3.00		0,0243	1,152	
<p>PVC Alt Ray / Bottom Rail</p>	L-3703	3.00	50	0,0225	0,200	Adet Pcs

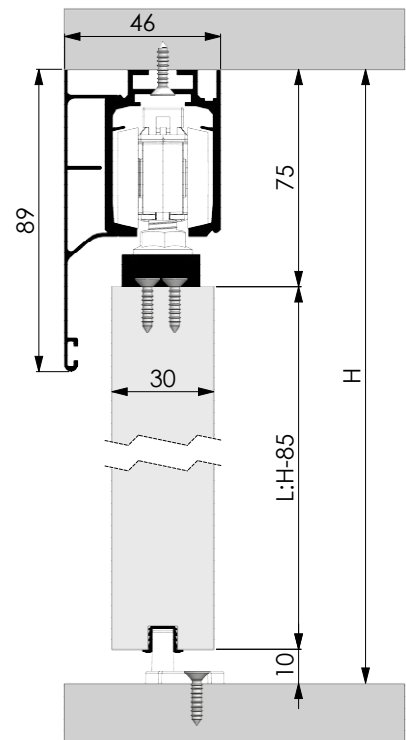

Accessories

Aksesuar



es



AKSESUAR GRUBU ACCESSORIES GROUP

L-4101 MASA PİMİ / TABLE PIN

1 Set İçeriği | 1 Set Includes

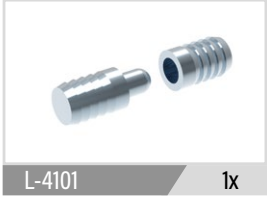

L-4101 1x

L-4113 HAREKETLİ TABLA DESTEK ELEMANI / MOVING TABLE SUPPORT PART

1 Set İçeriği | 1 Set Includes



L-4113 1x

Code	T (mm)	Box	Volume (m³)	Weight (kg)	Birim / Unit
L-4101	-	1000	0,0096	8,7	1 Adet / 1 Piece

Code	T (mm)	Box	Volume (m³)	Weight (kg)	Birim / Unit
L-4113	-	1000	0,035	22,46	1 Adet / 1 Piece

L-4102 HALATLI MASA RAYI MONTAJ ELEMANLARI / TABLE RAIL MECHANISM WITH STEEL ROPE MOUNTING ELEMENTS

1 Set İçeriği | 1 Set Includes

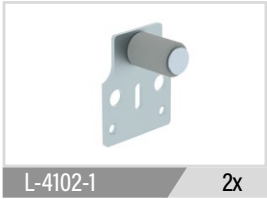

L-4102-1 2x

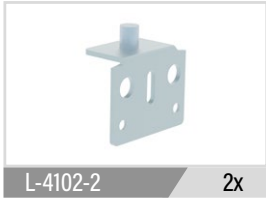

L-4102-2 2x



L-4102-3 1x



L-4102-4 1x



L-4101 8x

Code	T (mm)	Box	Volume (m³)	Weight (kg)	Birim / Unit
L-4102	-	120	0,035	31,85	11k / 1 Set

L-4111 METAL ÇEK-GER APARATI / METAL PULL TENSION

1 Set İçeriği | 1 Set Includes

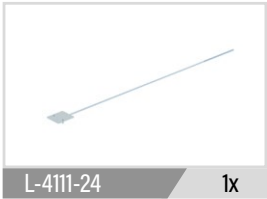

L-4111-24 1x



L-4111-25 1x



L-4111-2 1x



L-3705 2x



L-4111-21 1x



L-4111-22 6x

Code	T (mm)	Box	Volume (m³)	Weight (kg)	Birim / Unit
L-4111	-	40	0,404	36	11k / 1 Set

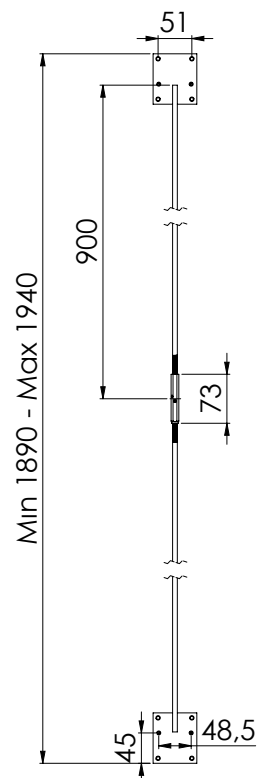

HALATLI MASA RAYI TAKIMI / TABLE RAIL SET WITH STEEL ROPE



1 Set İeriđi | 1 Set Includes

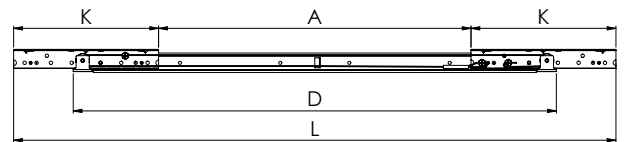

Code	Box	Volume (m ³)	Weight (kg)	Birim / Unit
L-4103	10	0,0272	22,2	1Tk / 1 Set
L-4106	10	0,0272	26,5	1Tk / 1 Set
L-4115	10	0,0311	28,5	1Tk / 1 Set

Code	D	K	A	L
L-4103	770	230	500	960
L-4106	770	350	500	1200
L-4115	1050	350	720	1415

ASANSÖRLÜ MASA RAYI TAKIMI / TABLE RAIL SET WITH LIFT

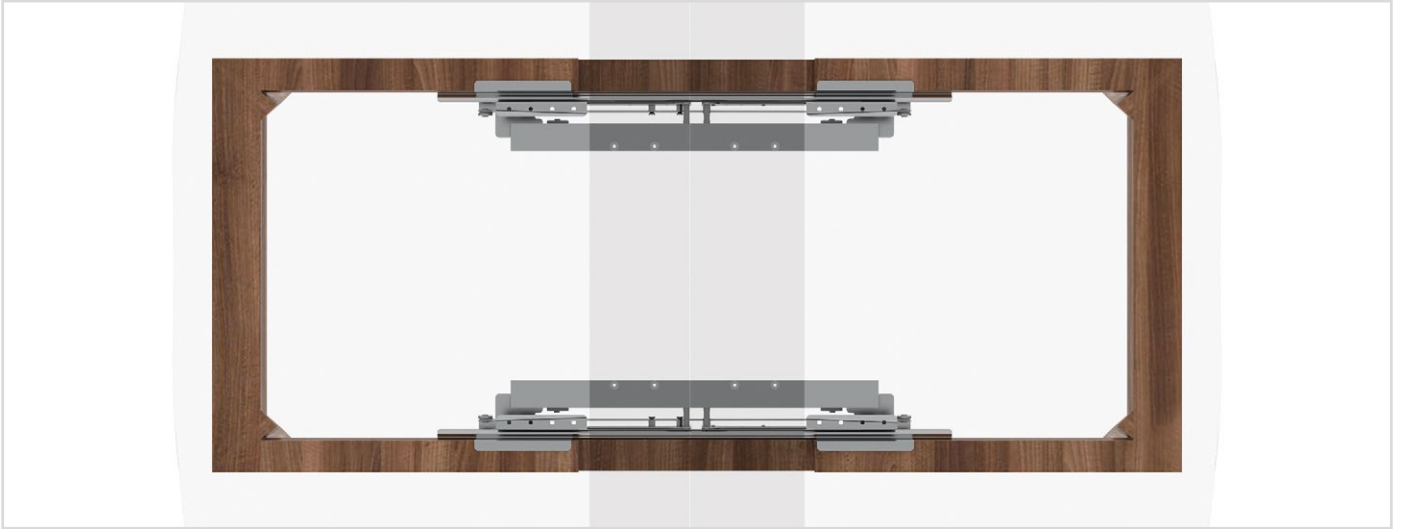

1 Set İeriđi | 1 Set Includes

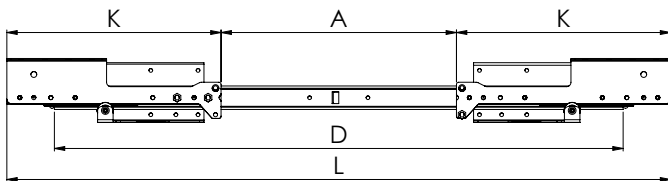
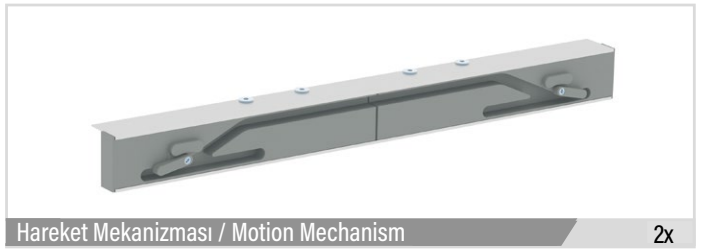
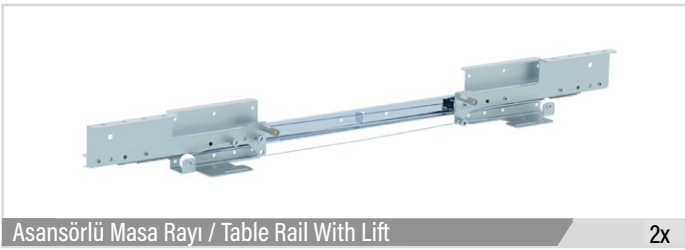

Code	Mode Tray (mm)	Box	Volume (m³)	Weight (kg)	Birim / Unit
L-4114	285	2	0,0315	7800	1Tk / 1Set
L-4116	450	2	0,0370	9,000	1Tk / 1Set

Code	D	K	A	L
L-4114	770	290	490	1070
L-4116	1070	290	605	1186

L-4109 YAVAŞLATICI / SOFT CLOSING MECHANISM

1 Set İçeriği | 1 Set Includes

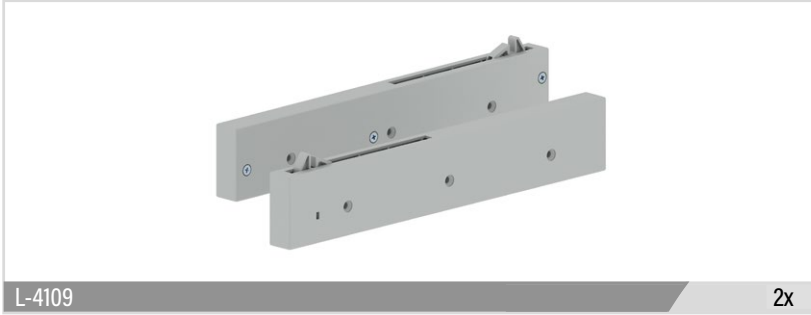

L-4109

2x



L-4109-4

1x



L-4109-5

1x

Code	T (mm)	Box	Volume (m ³)	Weight (kg)	Birim / Unit
L-4109	-	40	0,065	24,7	1Tk / 1Set

L-4110 YAVAŞLATICI / SOFT CLOSING MECHANISM

1 Set İçeriği | 1 Set Includes

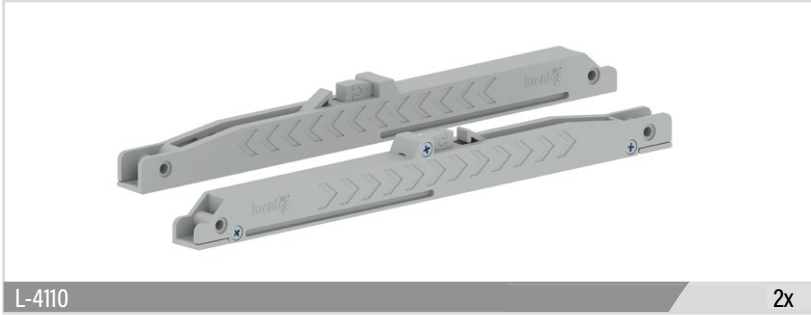

L-4110

2x

Code	T (mm)	Box	Volume (m ³)	Weight (kg)	Birim / Unit
L-4110	-	65	0,035	10	1Tk / 1Set

L-1258-8 YAVAŞLATICI / SOFT CLOSING MECHANISM

1 Set İçeriği | 1 Set Includes

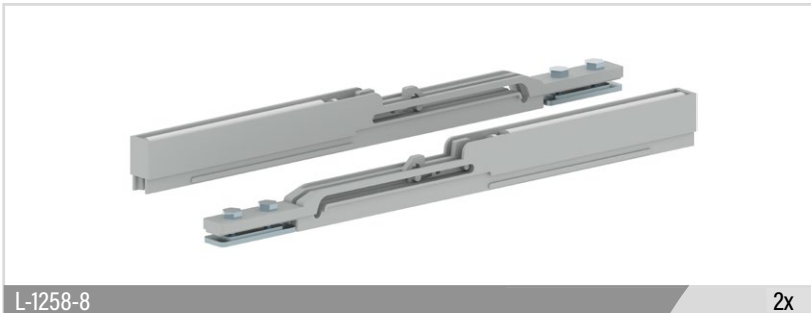

L-1258-8

2x

Code	T (mm)	Box	Volume (m ³)	Weight (kg)	Birim / Unit
L-1258-8	-	200	0,0315	22,3	1Tk / 1Set

STARAX®

© Copyright 2024

Bu katalog STAR MUTFAK ve MOBİLYA AKSESUARLARI SAN. ve TİC. A.Ş. tarafından ürün tanıtımı için hazırlanmıştır. Yazılı izin olmaksızın tamamı veya bir bölümü kopyalanamaz. STAR MUTFAK tüm ürünlerinde önceden haber vermeksizin değişiklik yapma hakkını saklı tutar.

This catalogue; prepared by STAR MUTFAK ve MOBİLYA AKSESUARLARI SAN. ve TİC. A.Ş. is for presentation of products. Can not be copied all or partly without written permission. STAR MUTFAK reserve the right to make changes for all products without prior notice.

STAR MUTFAK VE MOBİLYA AKSESUARLARI SAN. TİC. A.Ş.

Velimese OSB Mah. 236. Sokak No:18 Ergene

59930 Tekirdag - Türkiye

Tel: +90 282 444 53 54 Fax: +90 282 502 63 80

www.starax.com.tr

www.lucido.com.tr





www.lucido.com.tr